

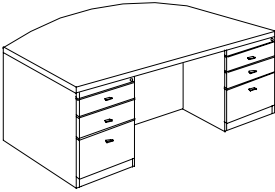

Model	Description	Dimension	List Price
<b>MV 4272 BD</b> 	<b>Double Pedestal Executive - Bow Top Desk</b>	depth 42 width 72 height 30 KD Weight * 331 cubic feet 27.758 cubic meter 0.781	<b>\$2,199.60</b>
<b>MV 3672 ED</b> 	<b>Double Pedestal Executive Desk</b>	depth 36 width 72 height 30 KD Weight * 320 cubic feet 27.088 cubic meter 0.767	<b>\$2,038.40</b>
<b>MV 3666 ED</b> 	<b>Double Pedestal Executive Desk</b>	depth 36 width 66 height 30 KD Weight * 310 cubic feet 26.699 cubic meter 0.756	<b>\$1,872.00</b>
<b>MV 3066 ED</b> 	<b>Double Pedestal Executive Desk</b> 24" X 66" Chassis with 30" X 66" Worksurface	depth 30 width 66 height 30 KD Weight * 252 cubic feet 18.894 cubic meter 0.535	<b>\$1,664.00</b>

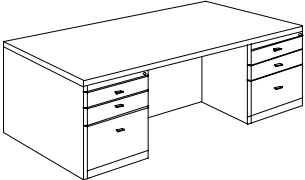
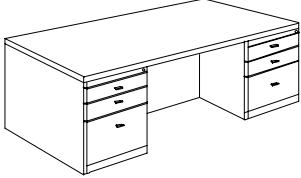
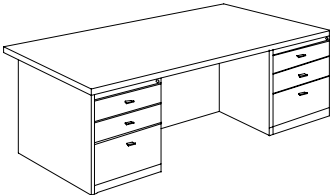
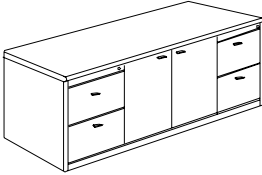
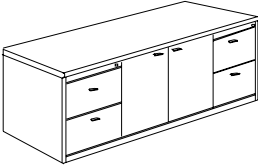
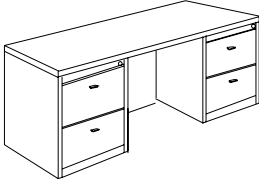
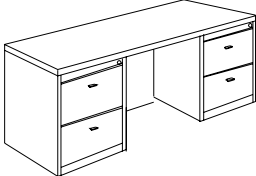
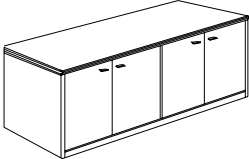
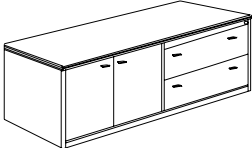

\* This weight does not include Pallet weight

Model	Description	Dimension	List Price
<b>MV 2472 SCM</b> 	Storage Credenza	depth 24 width 72 height 30 KD Weight * 352 cubic feet 22.956 cubic meter 0.650	<b>\$2,132.00</b>
<b>MV 2466 SCM</b> 	Storage Credenza	depth 24 width 66 height 30 KD Weight * 323 cubic feet 21.649 cubic meter 0.613	<b>\$2,028.00</b>
<b>MV 2472 KC</b> 	Knee Space Credenza (also available with BBF Pedestals)	depth 24 width 72 height 30 KD Weight * 236 cubic feet 18.824 cubic meter 0.533	<b>\$1,716.00</b>
<b>MV 2466 KC</b> 	Knee Space Credenza (also available with BBF Pedestals)	depth 24 width 66 height 30 KD Weight * 228 cubic feet 18.471 cubic meter 0.523	<b>\$1,664.00</b>
<b>MV 2472 DCC</b> 	Four Door Credenza	depth 24 width 72 height 30 KD Weight * 278 cubic feet 10.560 cubic meter 0.299	<b>\$1,866.80</b>
<b>MV 2472 CFC</b> 	Cabinet Lateral Credenza	depth 24 width 72 height 30 KD Weight * 295 cubic feet 22.461 cubic meter 0.636	<b>\$1,944.80</b>

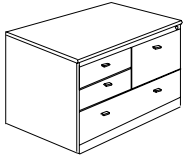
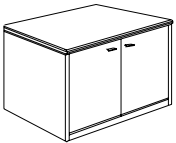
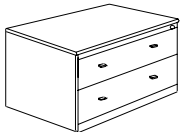
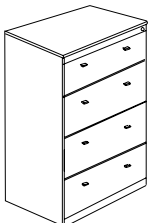
\* This weight does not include Pallet weight

Model	Description	Dimension	List Price
<b>MV 2472 DFC</b> 	<b>Lateral File Credenza</b>	depth 24	<b>\$2,028.00</b>
		width 72	
height 30			
KD Weight * 313			
cubic feet 34.363			
cubic meter 0.973			
<b>MV 2436 CP</b> 	<b>Combo Pedestal</b> with 24" x 36" Top	depth 24	<b>\$1,560.00</b>
		width 36	
height 30			
KD Weight * 196			
cubic feet 17.234			
cubic meter 0.488			
<b>MV 2436 DC</b> 	<b>Two Door Cabinet</b> with 24" x 36" Top	depth 24	<b>\$936.00</b>
		width 36	
height 30			
KD Weight * 141			
cubic feet 5.333			
cubic meter 0.151			
<b>MV 2436 LF</b> 	<b>Lateral File</b>	depth 24	<b>\$1,014.00</b>
		width 36	
height 30			
KD Weight * 159			
cubic feet 17.234			
cubic meter 0.488			
<b>MV 2436 FDLF</b> 	<b>4 Drawer Lateral File</b>	depth 24	<b>\$1,872.00</b>
		width 36	
height 55			
KD Weight * 273			
cubic feet 31.114			
cubic meter 0.881			

\* This weight does not include Pallet weight

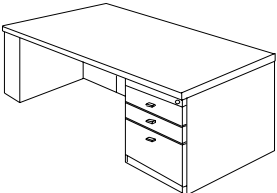
Model	Description	Dimension		List Price
<b>MV 4272 BSL</b>	<b>Left Pedestal Executive Bow Top Desk</b>	depth	42	<b>\$1,716.00</b>
	width	72		
	height	30		
	KD Weight *	278		
	cubic feet	24.792		
	cubic meter	0.702		
	<b>MV 4272 BSR</b>	<b>Right Pedestal Executive Bow Top Desk</b>	depth	42
	width	72		
	height	30		
	KD Weight *	278		
	cubic feet	24.792		
	cubic meter	0.702		
	<b>MV 3672 ESL</b>	<b>Left Pedestal Executive Desk</b>	depth	36
	width	72		
	height	30		
	KD Weight *	267		
	cubic feet	24.298		
	cubic meter	0.688		
	<b>MV 3672 ESR</b>	<b>Right Pedestal Executive Desk</b>	depth	36
	width	72		
	height	30		
	KD Weight *	267		
	cubic feet	24.298		
	cubic meter	0.688		

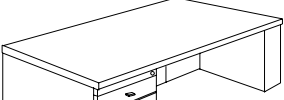

\* This weight does not include Pallet weight

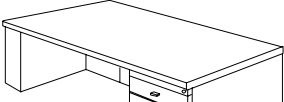
Model	Description	Dimension		List Price
<b>MV 3666 ESL</b>	<b>Left Pedestal Executive Desk</b>	depth	36	<b>\$1,560.00</b>
		width	66	
		height	30	
		KD Weight *	257	
		cubic feet	23.909	
		cubic meter	0.677	

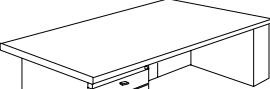
<b>MV 3666 ESR</b>	<b>Right Pedestal Executive Desk</b>	depth	36	<b>\$1,560.00</b>
		width	66	
		height	30	
		KD Weight *	257	
		cubic feet	23.909	
		cubic meter	0.677	

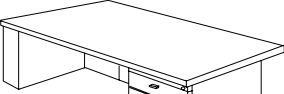
<b>MV 3066 ESL</b>	<b>Left Pedestal Executive Desk</b> 24" X 66" Chassis with 30" X 66" Worksurface	depth	30	<b>\$1,336.40</b>
		width	66	
		height	30	
		KD Weight *	211	
		cubic feet	16.881	
		cubic meter	0.478	

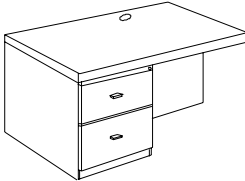
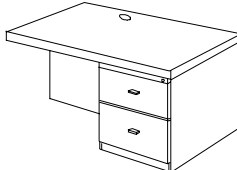
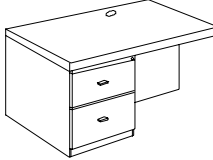
<b>MV 3066 ESR</b>	<b>Right Pedestal Executive Desk</b> 24" X 66" Chassis with 30" X 66" Worksurface	depth	30	<b>\$1,336.40</b>
		width	66	
		height	30	
		KD Weight *	211	
		cubic feet	16.881	
		cubic meter	0.478	

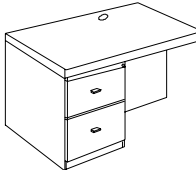
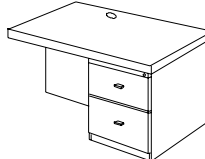
Model	Description	Dimension	List Price
<b>MV 48 RL</b> 	<b>Executive 48" Left Return</b>	depth 24	<b>\$910.00</b>
		width 48	
height 30			
KD Weight * 137			
cubic feet 10.101			
cubic meter 0.286			
<b>MV 48 RR</b> 	<b>Executive 48" Right Return</b>	depth 24	<b>\$910.00</b>
		width 48	
height 30			
KD Weight * 137			
cubic feet 10.101			
cubic meter 0.286			
<b>MV 42 RL</b> 	<b>Executive 42" Left Return</b>	depth 24	<b>\$806.00</b>
		width 42	
height 30			
KD Weight * 129			
cubic feet 9.783			
cubic meter 0.277			
<b>MV 42 RR</b> 	<b>Executive 42" Right Return</b>	depth 24	<b>\$806.00</b>
		width 42	
height 30			
KD Weight * 129			
cubic feet 9.783			
cubic meter 0.277			
<b>MV 36 RL</b> 	<b>Executive 36" Left Return</b>	depth 24	<b>\$754.00</b>
		width 36	
height 30			
KD Weight * 120			
cubic feet 9.465			
cubic meter 0.268			
<b>MV 36 RR</b> 	<b>Executive 36" Right Return</b>	depth 24	<b>\$754.00</b>
		width 36	
height 30			
KD Weight * 120			
cubic feet 9.465			
cubic meter 0.268			

\* This weight does not include Pallet weight

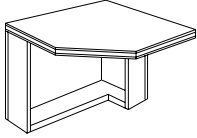
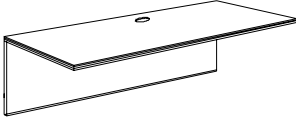
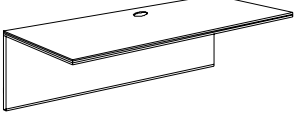
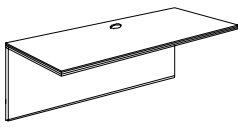
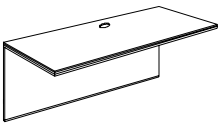
Model	Description	Dimension		List Price
<b>MV 3636 CU</b>	<b>Corner Unit</b>	depth	36	<b>\$696.80</b>
		width	36	
		height	30	
		KD Weight *	93	
		cubic feet	10.206	
		cubic meter	0.289	
<b>MV 48 EB</b>	<b>Executive 48" Bridge</b>	depth	24	<b>\$374.40</b>
		width	48	
		height	30	
		KD Weight *	69	
		cubic feet	2.825	
		cubic meter	0.080	
<b>MV 42 EB</b>	<b>Executive 42" Bridge</b>	depth	24	<b>\$338.00</b>
		width	42	
		height	30	
		KD Weight *	62	
		cubic feet	2.507	
		cubic meter	0.071	
<b>MV 36 EB</b>	<b>Executive 36" Bridge</b>	depth	24	<b>\$291.20</b>
		width	36	
		height	30	
		KD Weight *	53	
		cubic feet	1.190	
		cubic meter	0.062	
<b>MV 30 EB</b>	<b>Executive 30" Bridge</b>	depth	24	<b>\$244.40</b>
		width	30	
		height	30	
		KD Weight *	44	
		cubic feet	1.872	
		cubic meter	0.053	

\* This weight does not include Pallet weight

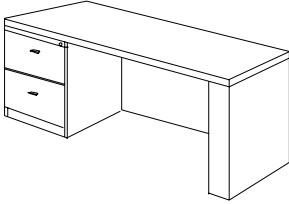
Model	Description	Dimension	List Price	
<b>MV 2472 CL</b> 	<b>Left Pedestal Credenza</b>	depth	24	<b>\$1,341.60</b>
		width	72	
		height	30	
		KD Weight *	209	
		cubic feet	19.707	
		cubic meter	0.558	

<b>MV 2472 CR</b> 	<b>Right Pedestal Credenza</b>	depth	24	<b>\$1,341.60</b>
		width	72	
		height	30	
		KD Weight *	209	
		cubic feet	19.707	
		cubic meter	0.558	

<b>MV 2466 CL</b> 	<b>Left Pedestal Credenza</b>	depth	24	<b>\$1,289.60</b>
		width	66	
		height	30	
		KD Weight *	201	
		cubic feet	19.353	
		cubic meter	0.548	

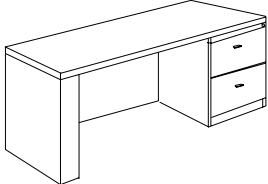
<b>MV 2466 CR</b> 	<b>Right Pedestal Credenza</b>	depth	24	<b>\$1,289.60</b>
		width	66	
		height	30	
		KD Weight *	201	
		cubic feet	19.353	
		cubic meter	0.548	

\* This weight does not include Pallet weight

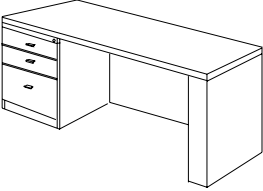
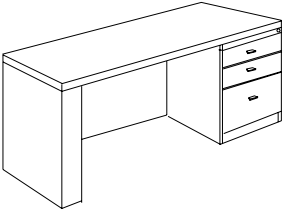
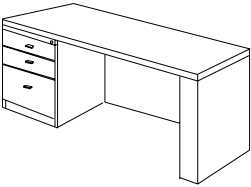
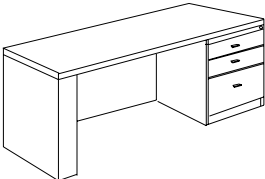
Model	Description	Dimension	List Price
<b>MV 2472 CBL</b> 	<b>Left Pedestal Credenza with 24" Deep BBF</b>	depth 24	<b>\$1,393.60</b>
		width 72	
		height 30	
		KD Weight * 236	
		cubic feet 23.380	
		cubic meter 0.662	
<b>MV 2472 CBR</b> 	<b>Right Pedestal Credenza with 24" Deep BBF</b>	depth 24	<b>\$1,393.60</b>
		width 72	
		height 30	
		KD Weight * 236	
		cubic feet 23.380	
		cubic meter 0.662	
<b>MV 2466 CBL</b> 	<b>Left Pedestal Credenza with 24" Deep BBF</b>	depth 24	<b>\$1,341.60</b>
		width 66	
		height 30	
		KD Weight * 228	
		cubic feet 23.026	
		cubic meter 0.652	
<b>MV 2466 CBR</b> 	<b>Right Pedestal Credenza with 24" Deep BBF</b>	depth 24	<b>\$1,341.60</b>
		width 66	
		height 30	
		KD Weight * 228	
		cubic feet 23.026	
		cubic meter 0.652	

\* This weight does not include Pallet weight

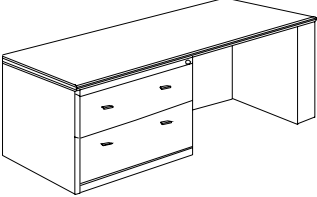
Model	Description	Dimension		List Price
<b>MV 2472 SFCL</b>	<b>Left Single Lateral File Credenza</b>	depth	24	<b>\$1,716.00</b>
		width	72	
		height	30	
		KD Weight *	248	
		cubic feet	27.476	
		cubic meter	0.778	

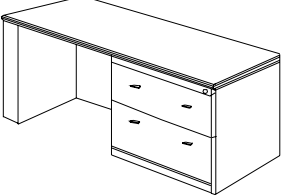
<b>MV 2472 SFCR</b>	<b>Right Single Lateral File Credenza</b>	depth	24	<b>\$1,716.00</b>
		width	72	
		height	30	
		KD Weight *	248	
		cubic feet	27.476	
		cubic meter	0.778	

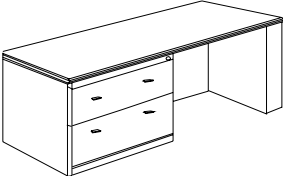
<b>MV 2466 SFCL</b>	<b>Left Single Lateral File Credenza</b>	depth	24	<b>\$1,664.00</b>
		width	66	
		height	30	
		KD Weight *	240	
		cubic feet	27.123	
		cubic meter	0.768	

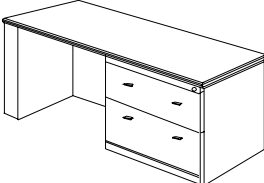
<b>MV 2466 SFCR</b>	<b>Right Single Lateral File Credenza</b>	depth	24	<b>\$1,664.00</b>
		width	66	
		height	30	
		KD Weight *	240	
		cubic feet	27.123	
		cubic meter	0.768	

\* This weight does not include Pallet weight

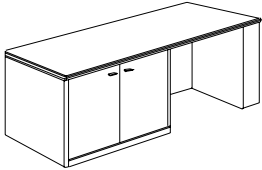

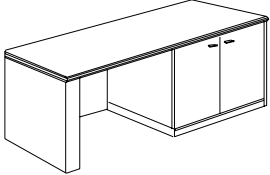
Model	Description	Dimension		List Price
<b>MV 2472 SCCL</b>	<b>Left Single Cabinet Credenza</b>	depth	24	<b>\$1,612.00</b>
		width	72	
		height	30	
		KD Weight *	230	
		cubic feet	15.575	
		cubic meter	0.441	

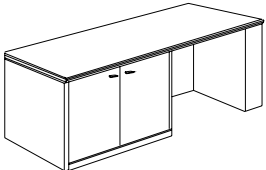
<b>MV 2472 SCCR</b>	<b>Right Single Cabinet Credenza</b>	depth	24	<b>\$1,612.00</b>
		width	72	
		height	30	
		KD Weight *	230	
		cubic feet	15.575	
		cubic meter	0.441	

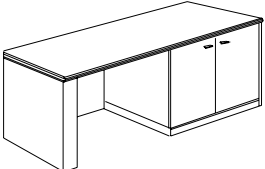
<b>MV 2466 SCCL</b>	<b>Left Single Cabinet Credenza</b>	depth	24	<b>\$1,554.80</b>
		width	66	
		height	30	
		KD Weight *	223	
		cubic feet	15.221	
		cubic meter	0.431	

<b>MV 2466 SCCR</b>	<b>Right Single Cabinet Credenza</b>	depth	24	<b>\$1,554.80</b>
		width	66	
		height	30	
		KD Weight *	223	
		cubic feet	15.221	
		cubic meter	0.431	

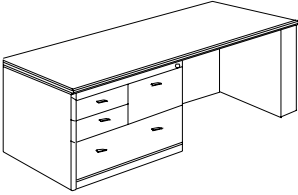
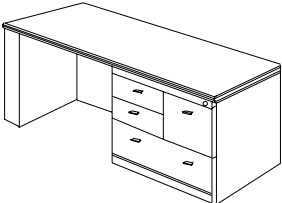
\* This weight does not include Pallet weight

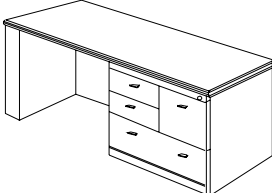
Model	Description	Dimension		List Price
MV 2472 CPCL	Left Combo Pedestal Credenza	depth	24	<b>\$2,392.00</b>
	width	72		
	height	30		
	KD Weight *	286		
	cubic feet	27.476		
	cubic meter	0.778		
	MV 2472 CPR	Right Combo Pedestal Credenza	depth	24
	width	72		
	height	30		
	KD Weight *	286		
	cubic feet	27.476		
	cubic meter	0.778		
	MV 2466 CPCL	Left Combo Pedestal Credenza	depth	24
	width	66		
	height	30		
	KD Weight *	278		
	cubic feet	27.123		
	cubic meter	0.768		
	MV 2466 CPR	Right Combo Pedestal Credenza	depth	24
	width	66		
	height	30		
	KD Weight *	278		
	cubic feet	27.123		
	cubic meter	0.768		

\* This weight does not include Pallet weight

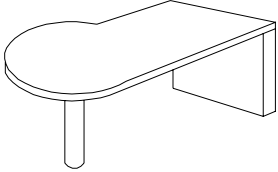
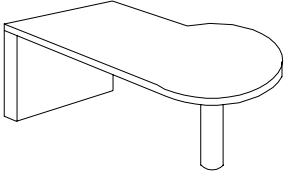
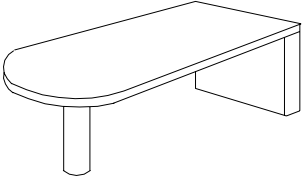
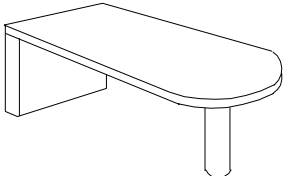
Model	Description	Dimension	List Price
<b>MV 4272 PTL</b> 	<b>Left Executive P-Top Desk</b>	depth 42	<b>\$1,071.20</b>
		width 72	
		height 30	
		KD Weight * 191	
		cubic feet 10.418	
		cubic meter 0.295	
<b>MV 4272 PTR</b> 	<b>Right Executive P-Top Desk</b>	depth 42	<b>\$1,071.20</b>
		width 72	
		height 30	
		KD Weight * 191	
		cubic feet 10.418	
		cubic meter 0.295	
<b>MV 3672 BTL</b> 	<b>Left Executive Bullet Top Desk</b>	depth 36	<b>\$1,019.20</b>
		width 72	
		height 30	
		KD Weight * 184	
		cubic feet 9.924	
		cubic meter 0.281	
<b>MV 3672 BTR</b> 	<b>Right Executive Bullet Top Desk</b>	depth 36	<b>\$1,019.20</b>
		width 72	
		height 30	
		KD Weight * 184	
		cubic feet 9.924	
		cubic meter 0.281	

\* This weight does not include Pallet weight

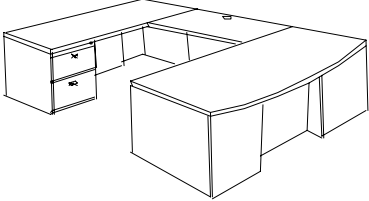
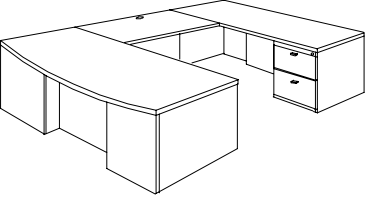
Model	Description	Dimension	List Price	
<b>Left Executive Bow Top "U" Unit</b>				
	<b>MV 4272 BSR</b> Right Pedestal Executive Bow Top Desk	depth 42 width 72 height 30 KD weight * 278 cubic feet 24.792 cubic meter 0.702	\$1,716.00	
	<b>MV 48 EB</b> Executive 48" Bridge	depth 24 width 48 height 30 KD weight * 69 cubic feet 2.825 cubic meter 0.080	\$374.40	
	<b>MV 2472 CL</b> Left Pedestal Credenza (For Optional Credenzas, please see page 14 to 18)	depth 24 width 72 height 30 KD weight * 209 cubic feet 19.707 cubic meter 0.558	\$1,341.60	
	<b>Unit Total :</b>		<b>\$3,432.00</b>	
	<b>Right Executive Bow Top "U" Unit</b>			
		<b>MV 4272 BSL</b> Left Pedestal Executive Bow Top Desk	depth 42 width 72 height 30 KD weight * 278 cubic feet 24.792 cubic meter 0.702	\$1,716.00
		<b>MV 48 EB</b> Executive 48" Bridge	depth 24 width 48 height 30 KD weight * 69 cubic feet 2.825 cubic meter 0.080	\$374.40
		<b>MV 2472 CR</b> Right Pedestal Credenza (For Optional Credenzas, please see page 14 to 18)	depth 24 width 72 height 30 KD weight * 209 cubic feet 19.707 cubic meter 0.558	\$1,341.60
		<b>Unit Total :</b>		<b>\$3,432.00</b>

\* This weight does not include Pallet weight

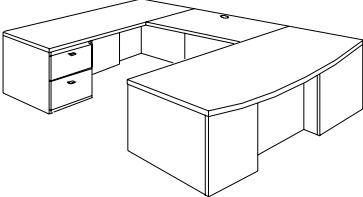
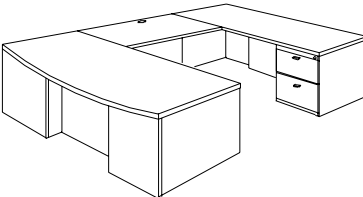
Model	Description	Dimension	List Price	
<b>Left Executive Bow Top "U" Unit</b>				
	<b>MV 4272 BSR</b> Right Pedestal Executive Bow Top Desk	depth 42 width 72 height 30 KD weight * 278 cubic feet 24.792 cubic meter 0.702	\$1,716.00	
	<b>MV 42 EB</b> Executive 42" Bridge	depth 24 width 42 height 30 KD weight * 62 cubic feet 2.507 cubic meter 0.071	\$338.00	
	<b>MV 2472 CL</b> Left Pedestal Credenza (For Optional Credenzas, please see page 14 to 18)	depth 24 width 72 height 30 KD weight * 209 cubic feet 19.707 cubic meter 0.558	\$1,341.60	
	<b>Unit Total :</b>		<b>\$3,395.60</b>	
	<b>Right Executive Bow Top "U" Unit</b>			
		<b>MV 4272 BSL</b> Left Pedestal Executive Bow Top Desk	depth 42 width 72 height 30 KD weight * 278 cubic feet 24.792 cubic meter 0.702	\$1,716.00
		<b>MV 42 EB</b> Executive 42" Bridge	depth 24 width 42 height 30 KD weight * 62 cubic feet 2.507 cubic meter 0.071	\$338.00
		<b>MV 2472 CR</b> Right Pedestal Credenza (For Optional Credenzas, please see page 14 to 18)	depth 24 width 72 height 30 KD weight * 209 cubic feet 19.707 cubic meter 0.558	\$1,341.60
		<b>Unit Total :</b>		<b>\$3,395.60</b>

\* This weight does not include Pallet weight

Model	Description	Dimension	List Price
-------	-------------	-----------	------------

**Left Executive "U" Unit**

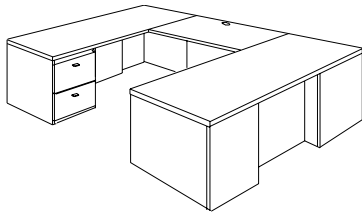

**MV 3672 ESR**  
Right Pedestal Executive Desk

depth 36  
width 72  
height 30  
KD weight \* 267  
cubic feet 27.088  
cubic meter 0.767

\$1,632.80

**MV 48 EB**  
Executive 48" Bridge

depth 24  
width 48  
height 30  
KD weight \* 69  
cubic feet 2.437  
cubic meter 0.069

\$374.40

**MV 2472 CL**  
Left Pedestal Credenza  
(For Optional Credenzas, please see page 14 to 18)

depth 24  
width 72  
height 30  
KD weight \* 209  
cubic feet 19.707  
cubic meter 0.558

\$1,341.60

**Unit Total : \$3,348.80**

**Right Executive "U" Unit**

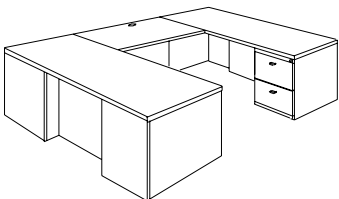

**MV 3672 ESL**  
Left Pedestal Executive Desk

depth 36  
width 72  
height 30  
KD weight \* 267  
cubic feet 27.088  
cubic meter 0.767

\$1,632.80

**MV 48 EB**  
Executive 48" Bridge

depth 24  
width 48  
height 30  
KD weight \* 69  
cubic feet 2.437  
cubic meter 0.069

\$374.40

**MV 2472 CR**  
Right Pedestal Credenza  
(For Optional Credenzas, please see page 14 to 18)

depth 24  
width 72  
height 30  
KD weight \* 209  
cubic feet 19.707  
cubic meter 0.558

\$1,341.60

**Unit Total : \$3,348.80**

\* This weight does not include Pallet weight

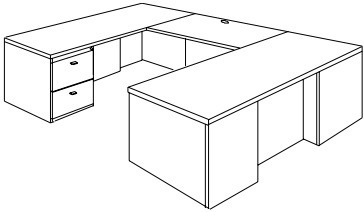
Model	Description	Dimension	List Price
<b>Left Executive "U" Unit</b>			
	<b>MV 3672 ESR</b> Right Pedestal Executive Desk	depth 36 width 72 height 30 KD weight * 267 cubic feet 27.088 cubic meter 0.767	\$1,632.80
	<b>MV 42 EB</b> Executive 42" Bridge	depth 24 width 42 height 30 KD weight * 62 cubic feet 2.507 cubic meter 0.071	\$338.00
	<b>MV 2472 CL</b> Left Pedestal Credenza (For Optional Credenzas, please see page 14 to 18)	depth 24 width 72 height 30 KD weight * 209 cubic feet 19.707 cubic meter 0.558	\$1,341.60
	<b>Unit Total :</b>		<b>\$3,312.40</b>

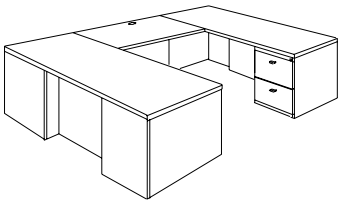
<b>Right Executive "U" Unit</b>			
	<b>MV 3672 ESL</b> Left Pedestal Executive Desk	depth 36 width 72 height 30 KD weight * 267 cubic feet 27.088 cubic meter 0.767	\$1,632.80
	<b>MV 42 EB</b> Executive 42" Bridge	depth 24 width 42 height 30 KD weight * 62 cubic feet 2.507 cubic meter 0.071	\$338.00
	<b>MV 2472 CR</b> Right Pedestal Credenza (For Optional Credenzas, please see page 14 to 18)	depth 24 width 72 height 30 KD weight * 209 cubic feet 19.707 cubic meter 0.558	\$1,341.60
	<b>Unit Total :</b>		<b>\$3,312.40</b>

Model	Description	Dimension	List Price
-------	-------------	-----------	------------

**Left Executive "U" Unit**

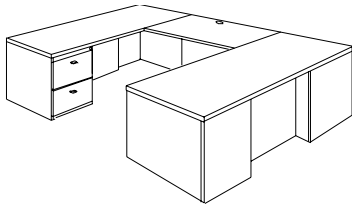

**MV 3666 ESR**  
Right Pedestal Executive Desk

depth	36	\$1,560.00
width	66	
height	30	
KD weight *	257	
cubic feet	26.699	
cubic meter	0.756	

**MV 48 EB**  
Executive 48" Bridge

depth	24	\$374.40
width	48	
height	30	
KD weight *	69	
cubic feet	2.437	
cubic meter	0.069	

**MV 2466 CL**  
Left Pedestal Credenza  
(For Optional Credenzas, please see page 14 to 18)

depth	24	\$1,289.60
width	66	
height	30	
KD weight *	201	
cubic feet	19.707	
cubic meter	0.558	

**Unit Total : \$3,224.00**

**Right Executive "U" Unit**

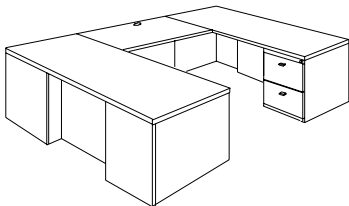

**MV 3666 ESL**  
Left Pedestal Executive Desk

depth	36	\$1,560.00
width	66	
height	30	
KD weight *	257	
cubic feet	26.699	
cubic meter	0.756	

**MV 48 EB**  
Executive 48" Bridge

depth	24	\$374.40
width	48	
height	30	
KD weight *	69	
cubic feet	2.437	
cubic meter	0.069	

**MV 2466 CR**  
Right Pedestal Credenza  
(For Optional Credenzas, please see page 14 to 18)

depth	24	\$1,289.60
width	66	
height	30	
KD weight *	201	
cubic feet	16.281	
cubic meter	0.461	

**Unit Total : \$3,224.00**

\* This weight does not include Pallet weight

Model	Description	Dimension	List Price
-------	-------------	-----------	------------

**Left Executive "U" Unit**

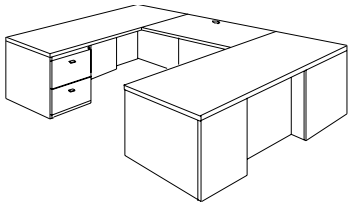

**MV 3666 ESR**  
Right Pedestal Executive Desk

depth 36  
width 66  
height 30  
KD weight \* 257  
cubic feet 26.699  
cubic meter 0.756

\$1,560.00

**MV 42 EB**  
Executive 42" Bridge

depth 24  
width 42  
height 30  
KD weight \* 62  
cubic feet 2.507  
cubic meter 0.071

\$338.00

**MV 2466 CL**  
Left Pedestal Credenza  
(For Optional Credenzas, please see page 14 to 18)

depth 24  
width 66  
height 30  
KD weight \* 201  
cubic feet 16.281  
cubic meter 0.461

\$1,289.60

**Unit Total : \$3,187.60**

**Right Executive "U" Unit**

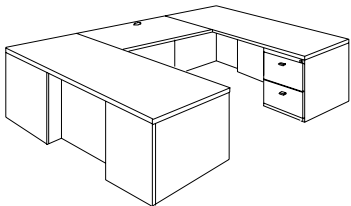

**MV 3666 ESL**  
Left Pedestal Executive Desk

depth 36  
width 66  
height 30  
KD weight \* 257  
cubic feet 26.699  
cubic meter 0.756

\$1,560.00

**MV 42 EB**  
Executive 42" Bridge

depth 24  
width 42  
height 30  
KD weight \* 62  
cubic feet 2.507  
cubic meter 0.071

\$338.00

**MV 2466 CR**  
Right Pedestal Credenza  
(For Optional Credenzas, please see page 14 to 18)

depth 24  
width 66  
height 30  
KD weight \* 201  
cubic feet 16.281  
cubic meter 0.461

\$1,289.60

**Unit Total : \$3,187.60**

\* This weight does not include Pallet weight

Model	Description	Dimension	List Price
-------	-------------	-----------	------------

**Left Executive "U" Unit**

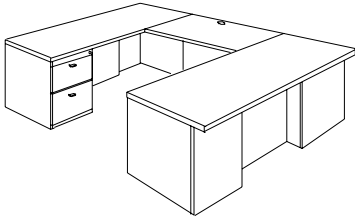

<b>MV 3066 ESR</b>	depth	30	\$1,336.40
Right Pedestal Executive Desk	width	66	
24" X 66" Chassis with 30" X 66" Worksurface	height	30	
	KD weight *	211	
	cubic feet	18.894	
	cubic meter	0.535	

<b>MV 48 EB</b>	depth	24	\$374.40
Executive 48" Bridge	width	48	
	height	30	
	KD weight *	69	
	cubic feet	2.437	
	cubic meter	0.069	

<b>MV 2466 CL</b>	depth	24	\$1,289.60
Left Pedestal Credenza	width	66	
(For Optional Credenzas, please see page 14 to 18)	height	30	
	KD weight *	201	
	cubic feet	16.281	
	cubic meter	0.461	

**Unit Total : \$3,000.40**

**Right Executive "U" Unit**

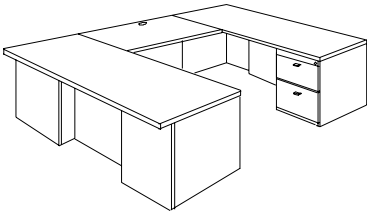

<b>MV 3066 ESL</b>	depth	30	\$1,336.40
Left Pedestal Executive Desk	width	66	
24" X 66" Chassis with 30" X 66" Worksurface	height	30	
	KD weight *	211	
	cubic feet	18.894	
	cubic meter	0.535	

<b>MV 48 EB</b>	depth	24	\$374.40
Executive 48" Bridge	width	48	
	height	30	
	KD weight *	69	
	cubic feet	2.437	
	cubic meter	0.069	

<b>MV 2466 CR</b>	depth	24	\$1,289.60
Right Pedestal Credenza	width	66	
(For Optional Credenzas, please see page 14 to 18)	height	30	
	KD weight *	201	
	cubic feet	16.281	
	cubic meter	0.461	

**Unit Total : \$3,000.40**

\* This weight does not include Pallet weight

Model	Description	Dimension	List Price
-------	-------------	-----------	------------

**Left Executive "U" Unit**

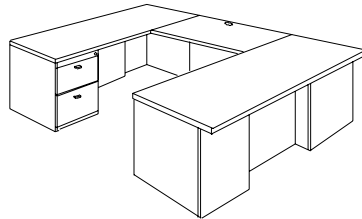

<b>MV 3066 ESR</b> Right Pedestal Executive Desk 24" X 66" Chassis with 30" X 66" Worksurface	depth 30 width 66 height 30 KD weight * 211 cubic feet 18.894 cubic meter 0.535	\$1,336.40
---	--	------------

<b>MV 42 EB</b> Executive 42" Bridge	depth 24 width 42 height 30 KD weight * 62 cubic feet 2.507 cubic meter 0.071	\$338.00
---	--	----------

<b>MV 2466 CL</b> Left Pedestal Credenza (For Optional Credenzas, please see page 14 to 18)	depth 24 width 66 height 30 KD weight * 201 cubic feet 16.281 cubic meter 0.461	\$1,289.60
---	--	------------

**Unit Total : \$2,964.00**

**Right Executive "U" Unit**

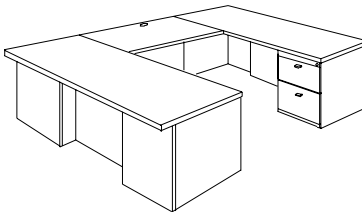

<b>MV 3066 ESL</b> Left Pedestal Executive Desk 24" X 66" Chassis with 30" X 66" Worksurface	depth 30 width 66 height 30 KD weight * 211 cubic feet 18.894 cubic meter 0.535	\$1,336.40
--	--	------------

<b>MV 42 EB</b> Executive 42" Bridge	depth 24 width 42 height 30 KD weight * 62 cubic feet 2.507 cubic meter 0.071	\$338.00
---	--	----------

<b>MV 2466 CR</b> Right Pedestal Credenza (For Optional Credenzas, please see page 14 to 18)	depth 24 width 66 height 30 KD weight * 201 cubic feet 16.281 cubic meter 0.461	\$1,289.60
--	--	------------

**Unit Total : \$2,964.00**

\* This weight does not include Pallet weight

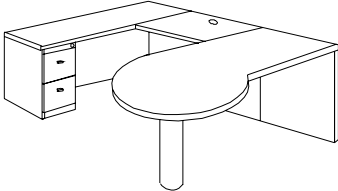
Model	Description	Dimension	List Price
<b>Left Executive P "U" Unit</b>			
	<b>MV 4272 PTR</b> Right Executive P Top Desk	depth 42 width 72 height 30 KD weight * 191 cubic feet 10.418 cubic meter 0.295	\$1,071.20
	<b>MV 48 EB</b> Executive 48" Bridge	depth 24 width 48 height 30 KD weight * 69 cubic feet 2.437 cubic meter 0.069	\$374.40
	<b>MV 2472 CL</b> Left Pedestal Credenza (For Optional Credenzas, please see page 14 to 18)	depth 24 width 72 height 30 KD weight * 209 cubic feet 19.707 cubic meter 0.558	\$1,341.60
	<b>Unit Total :</b>		<b>\$2,787.20</b>

**Right Executive P "U" Unit**

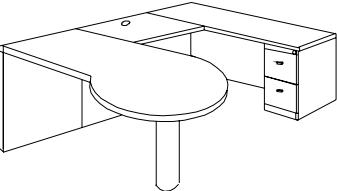
	<b>MV 4272 PTL</b> Left Executive P Top Desk	depth 42 width 72 height 30 KD weight * 191 cubic feet 10.418 cubic meter 0.295	\$1,071.20
	<b>MV 48 EB</b> Executive 48" Bridge	depth 24 width 48 height 30 KD weight * 69 cubic feet 2.437 cubic meter 0.069	\$374.40
	<b>MV 2472 CR</b> Right Pedestal Credenza (For Optional Credenzas, please see page 14 to 18)	depth 24 width 72 height 30 KD weight * 209 cubic feet 19.707 cubic meter 0.558	\$1,341.60
	<b>Unit Total :</b>		<b>\$2,787.20</b>

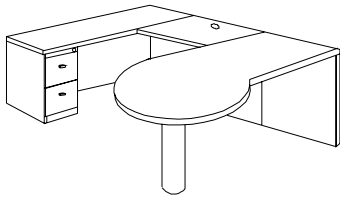
Model	Description	Dimension	List Price
<b>Left Executive P "U" Unit</b>			
	<b>MV 4272 PTR</b> Right Executive P Top Desk	depth 42 width 72 height 30 KD weight * 191 cubic feet 10.418 cubic meter 0.295	\$1,071.20
	<b>MV 42 EB</b> Executive 42" Bridge	depth 24 width 42 height 30 KD weight * 62 cubic feet 2.507 cubic meter 0.071	\$338.00
	<b>MV 2472 CL</b> Left Pedestal Credenza (For Optional Credenzas, please see page 14 to 18)	depth 24 width 72 height 30 KD weight * 209 cubic feet 19.707 cubic meter 0.558	\$1,341.60
	<b>Unit Total :</b>		<b>\$2,750.80</b>

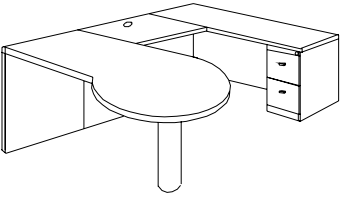
<b>Right Executive P "U" Unit</b>			
	<b>MV 4272 PTL</b> Left Executive P Top Desk	depth 42 width 72 height 30 KD weight * 191 cubic feet 8.582 cubic meter 0.243	\$1,071.20
	<b>MV 42 EB</b> Executive 42" Bridge	depth 24 width 42 height 30 KD weight * 62 cubic feet 10.418 cubic meter 0.295	\$338.00
	<b>MV 2472 CR</b> Right Pedestal Credenza (For Optional Credenzas, please see page 14 to 18)	depth 24 width 72 height 30 KD weight * 209 cubic feet 19.707 cubic meter 0.558	\$1,341.60
	<b>Unit Total :</b>		<b>\$2,750.80</b>

Model	Description	Dimension	List Price
-------	-------------	-----------	------------

**Left Executive Bullet "U" Unit**

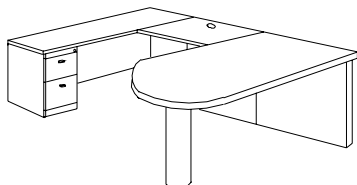

**MV 3672 BTR**  
Right Executive Bullet Top Desk

depth	36	\$1,019.20
width	72	
height	30	
KD weight *	184	
cubic feet	9.924	
cubic meter	0.281	

**MV 48 EB**  
Executive 48" Bridge

depth	24	\$374.40
width	48	
height	30	
KD weight *	69	
cubic feet	2.437	
cubic meter	0.069	

**MV 2472 CL**  
Left Pedestal Credenza  
(For Optional Credenzas, please see page 14 to 18)

depth	24	\$1,341.60
width	72	
height	30	
KD weight *	209	
cubic feet	19.707	
cubic meter	0.558	

**Unit Total : \$2,735.20**

**Right Executive Bullet "U" Unit**

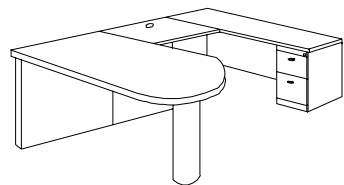

**MV 3672 BTL**  
Left Executive Bullet Top Desk

depth	36	\$1,019.20
width	72	
height	30	
KD weight *	184	
cubic feet	9.924	
cubic meter	0.281	

**MV 48 EB**  
Executive 48" Bridge

depth	24	\$374.40
width	48	
height	30	
KD weight *	69	
cubic feet	2.437	
cubic meter	0.069	

**MV 2472 CR**  
Right Pedestal Credenza  
(For Optional Credenzas, please see page 14 to 18)

depth	24	\$1,341.60
width	72	
height	30	
KD weight *	209	
cubic feet	19.707	
cubic meter	0.558	

**Unit Total : \$2,735.20**

\* This weight does not include Pallet weight

Model	Description	Dimension	List Price
-------	-------------	-----------	------------

**Left Executive Bullet "U" Unit**

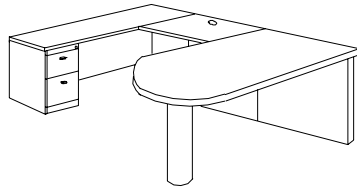

<b>MV 3672 BTR</b> Right Executive Bullet Top Desk	depth 36 width 72 height 30 KD weight * 184 cubic feet 9.924 cubic meter 0.281	\$1,019.20
---	---	------------

<b>MV 42 EB</b> Executive 42" Bridge	depth 24 width 42 height 30 KD weight * 62 cubic feet 2.507 cubic meter 0.071	\$338.00
---	--	----------

<b>MV 2472 CL</b> Left Pedestal Credenza (For Optional Credenzas, please see page 14 to 18)	depth 24 width 72 height 30 KD weight * 209 cubic feet 19.707 cubic meter 0.558	\$1,341.60
---	--	------------

**Unit Total : \$2,698.80**

**Right Executive Bullet "U" Unit**

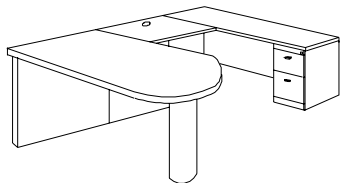

<b>MV 3672 BTL</b> Left Executive Bullet Top Desk	depth 36 width 72 height 30 KD weight * 184 cubic feet 9.924 cubic meter 0.281	\$1,019.20
--	---	------------

<b>MV 42 EB</b> Executive 42" Bridge	depth 24 width 42 height 30 KD weight * 62 cubic feet 2.507 cubic meter 0.071	\$338.00
---	--	----------

<b>MV 2472 CR</b> Right Pedestal Credenza (For Optional Credenzas, please see page 14 to 18)	depth 24 width 72 height 30 KD weight * 209 cubic feet 19.707 cubic meter 0.558	\$1,341.60
--	--	------------

**Unit Total : \$2,698.80**

\* This weight does not include Pallet weight

Model	Description	Dimension	List Price
-------	-------------	-----------	------------

**Left Executive Bow Top "L" Unit**

**MV 4272 BSR**

Right Pedestal Executive Bow Top Desk

depth	42
width	72
height	30
KD weight *	278
cubic feet	24.792
cubic meter	0.702

\$1,716.00

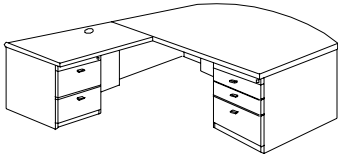

**MV 48 RL**

Executive 48" Left Return

depth	24
width	48
height	30
KD weight *	137
cubic feet	10.101
cubic meter	0.286

\$910.00

**Unit Total :**

**\$2,626.00**

**Right Executive Bow Top "L" Unit**

**MV 4272 BSL**

Left Pedestal Executive Bow Top Desk

depth	42
width	72
height	30
KD weight *	278
cubic feet	24.792
cubic meter	0.702

\$1,716.00

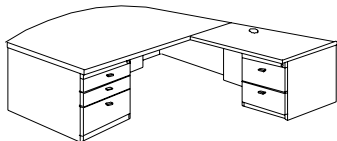

**MV 48 RR**

Executive 48" Right Return

depth	24
width	48
height	30
KD weight *	137
cubic feet	10.101
cubic meter	0.286

\$910.00

**Unit Total :**

**\$2,626.00**

\* This weight does not include Pallet weight

Model	Description	Dimension	List Price
-------	-------------	-----------	------------

**Left Executive Bow Top "L" Unit**

**MV 4272 BSR**  
Right Pedestal Executive Bow Top Desk

depth	42
width	72
height	30
KD weight *	278
cubic feet	24.792
cubic meter	0.702

\$1,716.00

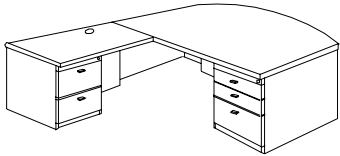

**MV 42 RL**  
Executive 42" Left Return

depth	24
width	42
height	30
KD weight *	129
cubic feet	9.783
cubic meter	0.277

\$806.00

**Unit Total :**

**\$2,522.00**

**Right Executive Bow Top "L" Unit**

**MV 4272 BSL**  
Left Pedestal Executive Bow Top Desk

depth	42
width	72
height	30
KD weight *	278
cubic feet	24.792
cubic meter	0.702

\$1,716.00

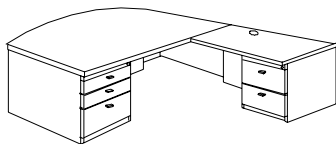

**MV 42 RR**  
Executive 42" Right Return

depth	24
width	42
height	30
KD weight *	129
cubic feet	9.783
cubic meter	0.277

\$806.00

**Unit Total :**

**\$2,522.00**

Model	Description	Dimension	List Price
-------	-------------	-----------	------------

**Left Executive " L" Unit**

**MV 3672 ESR**  
Right Pedestal Executive Desk

depth	36
width	72
height	30
KD weight *	267
cubic feet	24.298
cubic meter	0.688

\$1,632.80

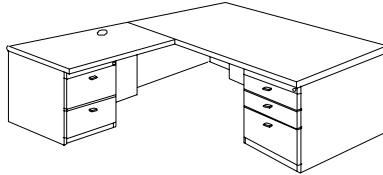

**MV 48 RL**  
Executive 48" Left Return

depth	24
width	48
height	30
KD weight *	137
cubic feet	10.101
cubic meter	0.286

\$910.00

**Unit Total :**

**\$2,542.80**

**Right Executive " L" Unit**

**MV 3672 ESL**  
Left Pedestal Executive Desk

depth	36
width	72
height	30
KD weight *	267
cubic feet	24.298
cubic meter	0.688

\$1,632.80

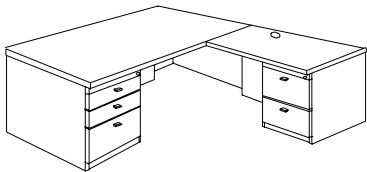

**MV 48 RR**  
Executive 48" Right Return

depth	24
width	48
height	30
KD weight *	137
cubic feet	10.101
cubic meter	0.286

\$910.00

**\$2,542.80**

\* This weight does not include Pallet weight

Model	Description	Dimension	List Price
-------	-------------	-----------	------------

**Left Executive " L" Unit**

**MV 3672 ESR**  
Right Pedestal Executive Desk

depth 36  
width 72  
height 30  
KD weight \* 267  
cubic feet 24.298  
cubic meter 0.688

\$1,632.80

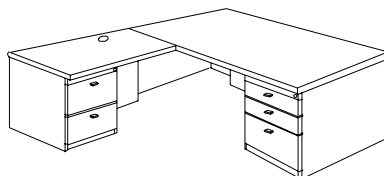

**MV 42 RL**  
Executive 42" Left Return

depth 24  
width 42  
height 30  
KD weight \* 129  
cubic feet 9.783  
cubic meter 0.277

\$806.00

**Unit Total : \$2,438.80**

**Right Executive " L" Unit**

**MV 3672 ESL**  
Left Pedestal Executive Desk

depth 36  
width 72  
height 30  
KD weight \* 267  
cubic feet 24.298  
cubic meter 0.688

\$1,632.80

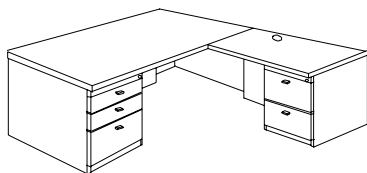

**MV 42 RR**  
Executive 42" Right Return

depth 24  
width 42  
height 30  
KD weight \* 129  
cubic feet 9.783  
cubic meter 0.277

\$806.00

**Unit Total : \$2,438.80**

\* This weight does not include Pallet weight

Model	Description	Dimension	List Price
-------	-------------	-----------	------------

**Left Executive " L" Unit**

**MV 3666 ESR**  
Right Pedestal Executive Desk

depth 36  
width 66  
height 30  
KD weight \* 260  
cubic feet 23.909  
cubic meter 0.677

\$1,560.00

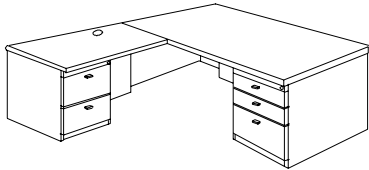

**MV 48 RL**  
Executive 48" Left Return

depth 24  
width 48  
height 30  
KD weight \* 137  
cubic feet 10.101  
cubic meter 0.286

\$910.00

**Unit Total : \$2,470.00**

**Right Executive " L" Unit**

**MV 3666 ESL**  
Left Pedestal Executive Desk

depth 36  
width 66  
height 30  
KD weight \* 260  
cubic feet 23.909  
cubic meter 0.677

\$1,560.00

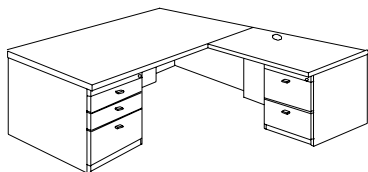

**MV 48 RR**  
Executive 48" Right Return

depth 24  
width 48  
height 30  
KD weight \* 137  
cubic feet 10.101  
cubic meter 0.286

\$910.00

**Unit Total : \$2,470.00**

\* This weight does not include Pallet weight

Model	Description	Dimension	List Price
-------	-------------	-----------	------------

**Left Executive " L" Unit**

**MV 3666 ESR**  
Right Pedestal Executive Desk

depth 36  
width 66  
height 30  
KD weight \* 260  
cubic feet 23.909  
cubic meter 0.677

\$1,560.00

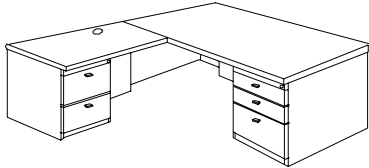

**MV 42 RL**  
Executive 42" Left Return

depth 24  
width 42  
height 30  
KD weight \* 129  
cubic feet 9.783  
cubic meter 0.277

\$806.00

**Unit Total : \$2,366.00**

**Right Executive " L" Unit**

**MV 3666 ESL**  
Left Pedestal Executive Desk

depth 36  
width 66  
height 30  
KD weight \* 260  
cubic feet 23.909  
cubic meter 0.677

\$1,560.00

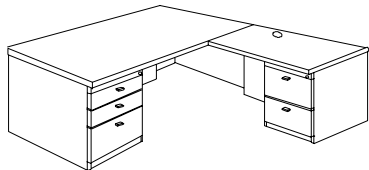

**MV 42 RR**  
Executive 42" Right Return

depth 24  
width 42  
height 30  
KD weight \* 129  
cubic feet 9.783  
cubic meter 0.277

\$806.00

**Unit Total : \$2,366.00**

\* This weight does not include Pallet weight

Model	Description	Dimension	List Price
-------	-------------	-----------	------------

**Left Executive " L" Unit**

**MV 3066 ESR**

Right Pedestal Executive Desk  
24" X 66" Chassis with 30" X 66" Worksurface

depth	30
width	66
height	30
KD weight *	211
cubic feet	16.881
cubic meter	0.478

\$1,336.40

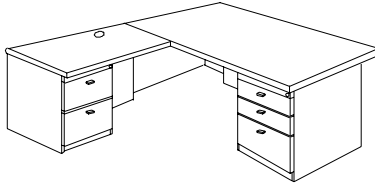

**MV 48 RL**

Executive 48" Left Return

depth	24
width	48
height	30
KD weight *	137
cubic feet	10.101
cubic meter	0.286

\$910.00

**Unit Total :**

**\$2,246.40**

**Right Executive " L" Unit**

**MV 3066 ESL**

Left Pedestal Executive Desk  
24" X 66" Chassis with 30" X 66" Worksurface

depth	30
width	66
height	30
KD weight *	211
cubic feet	16.881
cubic meter	0.478

\$1,336.40

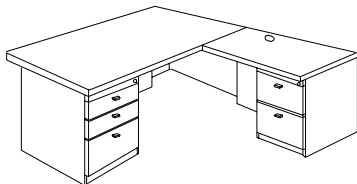

**MV 48 RR**

Executive 48" Right Return

depth	24
width	48
height	30
KD weight *	137
cubic feet	10.101
cubic meter	0.286

\$910.00

**Unit Total :**

**\$2,246.40**

\* This weight does not include Pallet weight

Model	Description	Dimension	List Price
-------	-------------	-----------	------------

**Left Executive " L" Unit**

**MV 3066 ESR**

Right Pedestal Executive Desk  
24" X 66" Chassis with 30" X 66" Worksurface

depth	30
width	66
height	30
KD weight *	211
cubic feet	16.881
cubic meter	0.478

\$1,336.40

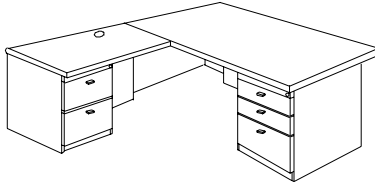

**MV 42 RL**

Executive 42" Left Return

depth	24
width	42
height	30
KD weight *	129
cubic feet	9.783
cubic meter	0.277

\$806.00

**Unit Total :**

**\$2,142.40**

**Right Executive " L" Unit**

**MV 3066 ESL**

Left Pedestal Executive Desk  
24" X 66" Chassis with 30" X 66" Worksurface

depth	30
width	66
height	30
KD weight *	211
cubic feet	16.881
cubic meter	0.478

\$1,336.40

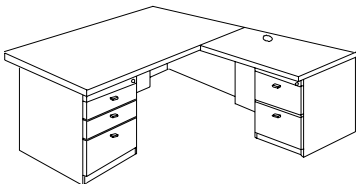

**MV 42 RR**

Executive 42" Right Return

depth	24
width	42
height	30
KD weight *	129
cubic feet	9.783
cubic meter	0.277

\$806.00

**Unit Total :**

**\$2,142.40**

\* This weight does not include Pallet weight

Model	Description	Dimension	List Price
-------	-------------	-----------	------------

**Left Executive P "L" Unit**

**MV 4272 PTR**  
Right Executive P Top Desk

depth 42  
width 72  
height 30  
KD weight \* 191  
cubic feet 10.418  
cubic meter 0.295

\$1,071.20

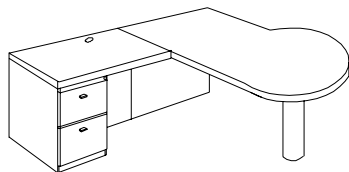

**MV 48 RL**  
Executive 48" Left Return

depth 24  
width 48  
height 30  
KD weight \* 137  
cubic feet 10.101  
cubic meter 0.286

\$910.00

**Unit Total : \$1,981.20**

**Right Executive P "L" Unit**

**MV 4272 PTL**  
Left Executive P Top Desk

depth 42  
width 72  
height 30  
KD weight \* 191  
cubic feet 8.582  
cubic meter 0.243

\$1,071.20

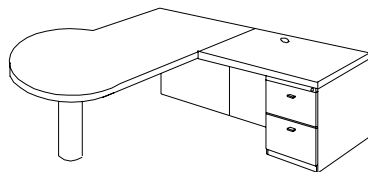

**MV 48 RR**  
Executive 48" Right Return

depth 24  
width 48  
height 30  
KD weight \* 137  
cubic feet 10.101  
cubic meter 0.286

\$910.00

**Unit Total : \$1,981.20**

\* This weight does not include Pallet weight

Model	Description	Dimension	List Price
-------	-------------	-----------	------------

**Left Executive P "L" Unit**

**MV 4272 PTR**  
Right Executive P Top Desk

depth 42  
width 72  
height 30  
KD weight \* 191  
cubic feet 8.582  
cubic meter 0.243

\$1,071.20

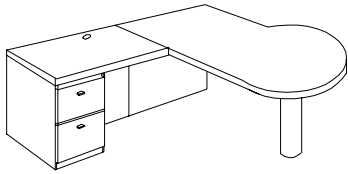

**MV 42 RL**  
Executive 42" Left Return

depth 24  
width 42  
height 30  
KD weight \* 129  
cubic feet 9.783  
cubic meter 0.277

\$806.00

**Unit Total : \$1,877.20**

**Right Executive P "L" Unit**

**MV 4272 PTL**  
Left Executive P Top Desk

depth 42  
width 72  
height 30  
KD weight \* 191  
cubic feet 8.582  
cubic meter 0.243

\$1,071.20

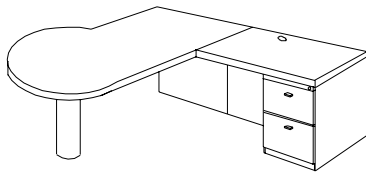

**MV 42 RR**  
Executive 42" Right Return

depth 24  
width 42  
height 30  
KD weight \* 129  
cubic feet 9.783  
cubic meter 0.277

\$806.00

**Unit Total : \$1,877.20**

\* This weight does not include Pallet weight

Model	Description	Dimension	List Price
-------	-------------	-----------	------------

**Left Executive Bullet "L" Unit**

<b>MV 3672 BTR</b>		depth	36	\$1,019.20
Right Executive Bullet Top Desk		width	72	
		height	30	
		KD weight *	184	
		cubic feet	8.087	
		cubic meter	0.229	

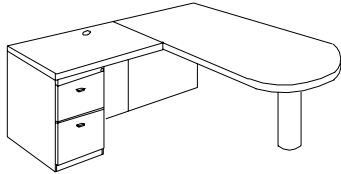

<b>MV 48 RL</b>		depth	24	\$910.00
Executive 48" Left Return		width	48	
		height	30	
		KD weight *	137	
		cubic feet	10.101	
		cubic meter	0.286	

**Unit Total : \$1,929.20**

**Right Executive Bullet "L" Unit**

<b>MV 3672 BTL</b>		depth	36	\$1,019.20
Left Executive Bullet Top Desk		width	72	
		height	30	
		KD weight *	184	
		cubic feet	8.087	
		cubic meter	0.229	

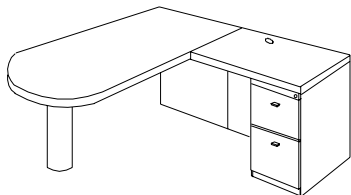

<b>MV 48 RR</b>		depth	24	\$910.00
Executive 48" Right Return		width	48	
		height	30	
		KD weight *	137	
		cubic feet	10.101	
		cubic meter	0.286	

**Unit Total : \$1,929.20**

\* This weight does not include Pallet weight

Model	Description	Dimension	List Price
-------	-------------	-----------	------------

**Left Executive Bullet "L" Unit**

**MV 3672 BTR**  
Right Executive Bullet Top Desk

depth 36  
width 72  
height 30  
KD weight \* 184  
cubic feet 9.924  
cubic meter 0.281

\$1,019.20

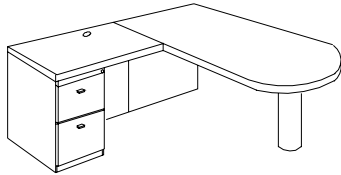

**MV 42 RL**  
Executive 42" Left Return

depth 24  
width 42  
height 30  
KD weight \* 129  
cubic feet 9.783  
cubic meter 0.277

\$806.00

**Unit Total : \$1,825.20**

**Right Executive Bullet "L" Unit**

**MV 3672 BTL**  
Left Executive Bullet Top Desk

depth 36  
width 72  
height 30  
KD weight \* 184  
cubic feet 9.924  
cubic meter 0.281

\$1,019.20

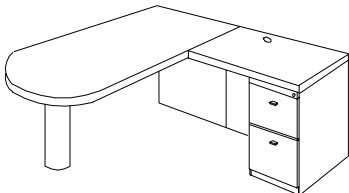

**MV 42 RR**  
Executive 42" Right Return

depth 24  
width 42  
height 30  
KD weight \* 129  
cubic feet 9.783  
cubic meter 0.277

\$806.00

**Unit Total : \$1,825.20**

\* This weight does not include Pallet weight

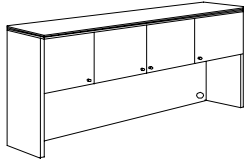
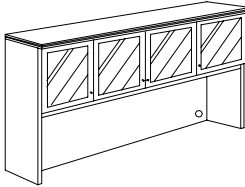
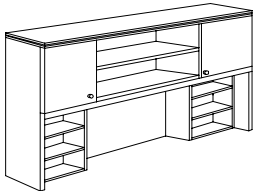
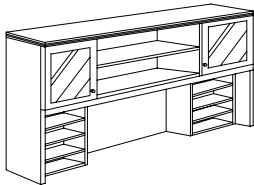
Model	Description	Dimension	List Price
<b>MV 1672 CH</b> 	<b>Credenza Hutch</b>	depth 16 width 72 height 42 KD Weight * 176 cubic feet 6.922 cubic meter 0.196	<b>\$1,300.00</b>
<b>MV 1672 CHG</b> 	<b>Glass Door Credenza Hutch ( Clear or frosted )</b>	depth 16 width 72 height 42 KD Weight * 177 cubic feet 6.922 cubic meter 0.196	<b>\$1,404.00</b>
<b>MV 1672 HH</b> 	<b>Credenza Home Hutch</b>	depth 16 width 72 height 42 KD Weight * 195 cubic feet 13.067 cubic meter 0.370	<b>\$1,554.80</b>
<b>MV 1672 HHG</b> 	<b>Glass door Credenza Home Hutch ( Clear or frosted )</b>	depth 16 width 72 height 42 KD weight * 195 cubic feet 11.160 cubic meter 0.316	<b>\$1,612.00</b>

\* This weight does not include Pallet weight

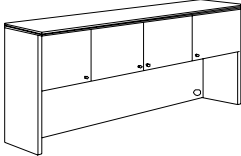
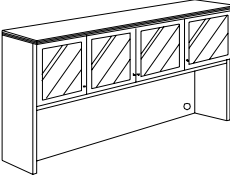
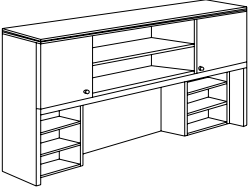
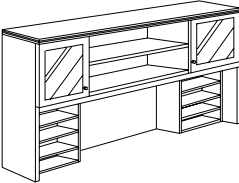
Model	Description	Dimension	List Price		
MV 1666 CH	Credenza Hutch	depth	16	<b>\$1,185.60</b>	
		width	66		
		height	42		
		KD Weight *	168		
		cubic feet	6.357		
		cubic meter	0.180		
		<hr/>			
		MV 1666 CHG	Credenza Hutch Glass Door Credenza Hutch ( Clear or frosted )	depth	16
width	66				
		height	42		
		KD Weight *	167		
		cubic feet	6.357		
		cubic meter	0.180		
		<hr/>			
		MV 1666 HH	Credenza Home Hutch	depth	16
width	66				
		height	42		
		KD Weight *	189		
		cubic feet	11.972		
		cubic meter	0.339		
		<hr/>			
		MV 1666 HHG	Glass door Credenza Home Hutch ( Clear or frosted )	depth	16
width	66				
		height	42		
		KD weight *	86		
		cubic feet	10.670		
		cubic meter	0.302		

\* This weight does not include Pallet weight

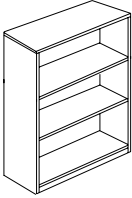
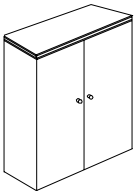
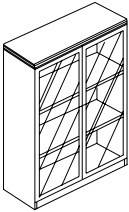
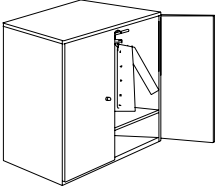
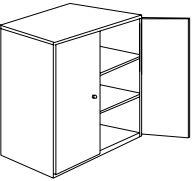
Model	Description	Dimension		List Price
<b>MV 1636 SHO</b> 	<b>Open Shelf Storage Hutch</b>	depth	16	<b>\$572.00</b>
		width	36	
		height	42	
		KD weight *	101	
		cubic feet	3.814	
		cubic meter	0.108	
<b>MV 1636 SHD</b> 	<b>Storage Hutch</b>	depth	16	<b>\$884.00</b>
		width	36	
		height	42	
		KD weight *	132	
		cubic feet	4.980	
		cubic meter	0.141	
<b>MV 1636 SHG</b> 	<b>Storage Hutch with Glass doors ( Clear or frosted )</b>	depth	16	<b>\$826.80</b>
		width	36	
		height	42	
		KD Weight *	126	
		cubic feet	5.615	
		cubic meter	0.159	
<b>MV 2436 WCH</b> 	<b>Wardrobe Cabinet Hutch</b>	depth	24	<b>\$1,175.20</b>
		width	36	
		height	42	
		KD weight *	157	
		cubic feet	5.933	
		cubic meter	0.168	
<b>MV 2436 SCH</b> 	<b>Storage Cabinet Hutch</b>	depth	24	<b>\$1,300.00</b>
		width	36	
		height	42	
		KD weight *	170	
		cubic feet	6.851	
		cubic meter	0.194	

\* This weight does not include Pallet weight

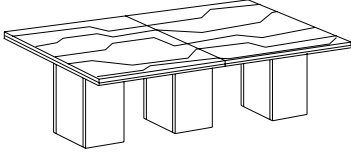
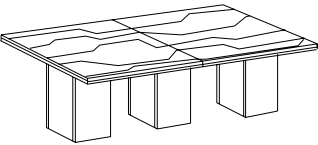
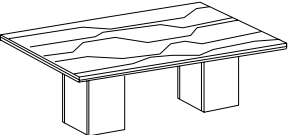
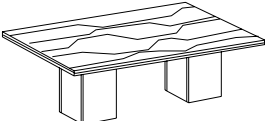
Model	Description	Dimension	List Price
<b>MV 48144 ACT</b>	<b>12-ft Rectangular Conference Table</b>	depth 48 width 144 height 30 KD weight * 486 cubic feet 30.937 cubic meter 0.876	<b>\$2,381.60</b>
			
<b>MV 48120 ACT</b>	<b>10-ft Rectangular Conference Table</b>	depth 48 width 120 height 30 KD Weight * 448 cubic feet 29.736 cubic meter 0.844	<b>\$1,924.00</b>
			
<b>MV 4896 ACT</b>	<b>8-ft Rectangular Conference Table</b>	depth 48 width 96 height 30 KD Weight * 328 cubic feet 21.684 cubic meter 0.614	<b>\$1,508.00</b>
			
<b>MV 3672 ACT</b>	<b>6-ft Rectangular Conference Table</b>	depth 36 width 72 height 30 KD Weight * 174 cubic feet 11.902 cubic meter 0.337	<b>\$1,196.00</b>
			

\* This weight does not include Pallet weight

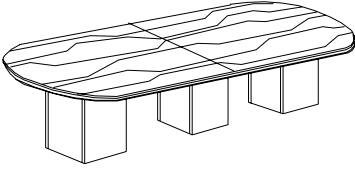
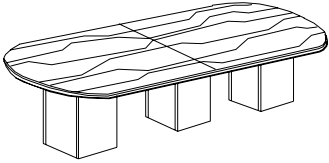
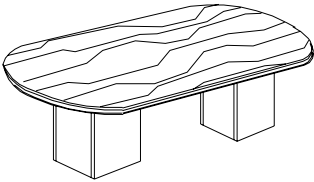
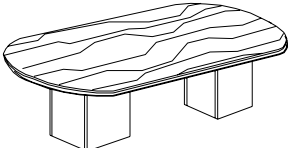
Model	Description	Dimension	List Price		
MV 48144 RTCT	12-ft Racetrack Conference Table	depth	48		
		width	144		
		height	30		
		KD weight *	471		
		cubic feet	30.937		
		cubic meter	0.876		
					<b>\$2,490.80</b>
MV 48120 RTCT	10-ft Racetrack Conference Table	depth	48		
		width	120		
		height	30		
		KD weight *	433		
		cubic feet	29.807		
		cubic meter	0.844		
					<b>\$2,262.00</b>
MV 4896 RTCT	8-ft Racetrack Conference Table	depth	48		
		width	96		
		height	30		
		KD weight *	313		
		cubic feet	21.684		
		cubic meter	0.614		
					<b>\$1,508.00</b>
MV 3672 RTCT	6-ft Racetrack Conference Table	depth	36		
		width	72		
		height	30		
		KD weight *	165		
		cubic feet	11.902		
		cubic meter	0.337		
					<b>\$1,196.00</b>

\* This weight does not include Pallet weight

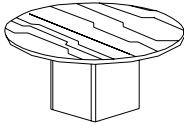
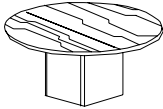
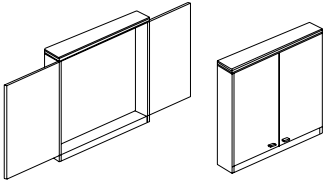
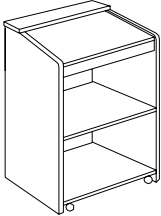
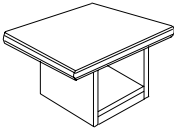
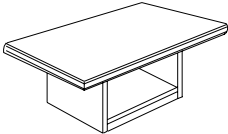
Model	Description	Dimension		List Price
<b>MV 48 RCT</b> 	<b>Round Conference Table</b>	diameter	48	<b>\$806.00</b>
		height	30	
		KD Weight *	147	
		cubic feet	10.772	
		cubic meter	0.305	
<b>MV 42 RCT</b> 	<b>Round Conference Table</b>	diameter	42	<b>\$696.80</b>
		height	30	
		KD Weight *	133	
		cubic feet	10.312	
		cubic meter	0.292	
<b>MV 4848 VB</b> 	<b>Visual Board with white board</b>	depth	5	<b>\$1,144.00</b>
		width	47	
		height	47	
		KD Weight *	112	
		cubic feet	9.641	
		cubic meter	0.273	
<b>MV 24 LT</b> 	<b>Lectern with fixed shelf and casters</b>	depth	20	<b>\$624.00</b>
		width	24	
		height	47	
		KD Weight *	104	
		cubic feet	3.426	
		cubic meter	0.097	
<b>MV 2424 OT</b> 	<b>Occasional End Table</b>	depth	24	<b>\$353.60</b>
		width	24	
		height	20	
		KD Weight *	42	
		cubic feet	3.779	
		cubic meter	0.107	
<b>MV 2448 OT</b> 	<b>Occasional Coffee Table</b>	depth	24	<b>\$488.80</b>
		width	48	
		height	18	
		KD Weight *	67	
		cubic feet	8.017	
		cubic meter	0.227	

\* This weight does not include Pallet weight

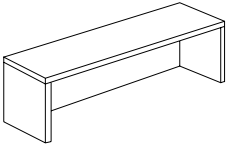
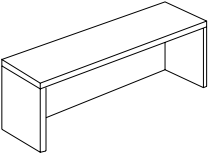
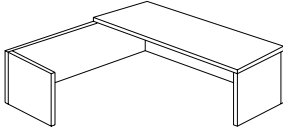
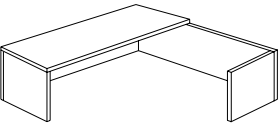
Model	Description	Dimension	List Price	
<b>MV 1472 TC</b> 	<b>Transaction Counter</b>	depth	14	<b>\$572.00</b>
		width	72	
		height	14	
		KD Weight *	66	
		cubic feet	2.755	
		cubic meter	0.078	
		<hr/>		
<b>MV 1466 TC</b> 	<b>Transaction Counter</b>	depth	14	<b>\$535.60</b>
		width	66	
		height	14	
		KD Weight *	57	
		cubic feet	2.543	
		cubic meter	0.072	
		<hr/>		
<b>Left L Unit Transaction Counter</b>				
<b>MV 8472 TCL L</b> 	<b>Front 1472 TC</b> Transaction Counter	depth	14	<b>\$572.00</b>
		width	72	
		height	14	
		KD weight *	66	
		cubic feet	2.755	
		cubic meter	0.078	
		<b>Side 84 CL L</b> Left L Transaction Counter		
width	13			
height	14			
KD weight *	47			
cubic feet	2.578			
cubic meter	0.073			
<b>Unit Total :</b>				<b>\$936.00</b>
<hr/>				
<b>Right L Unit Transaction Counter</b>				
<b>MV 8472 TCL R</b> 	<b>Front 1472 TC</b> Transaction Counter	depth	14	<b>\$572.00</b>
		width	72	
		height	14	
		KD weight *	66	
		cubic feet	2.755	
		cubic meter	0.078	
		<b>Side 84 CL R</b> Right L Transaction Counter		
width	13			
height	14			
KD weight *	47			
cubic feet	2.578			
cubic meter	0.073			
<b>Unit Total :</b>				<b>\$936.00</b>

\* This weight does not include Pallet weight

Model	Description	Dimension	List Price	
<b>Left L Unit Transaction Counter</b>				
<b>MV 8466 TCL L</b>	<b>Front 1466 TC</b> Transaction Counter	depth	14	<b>\$535.60</b>
		width	66	
		height	14	
		KD weight *	57	
		cubic feet	2.543	
		cubic meter	0.072	
		<b>Side 84 CL L</b>		
Left L Transaction Counter				
depth	84			
width	13			
height	14			
KD weight *	47			
cubic feet	2.578			
cubic meter	0.073			
<b>Unit Total :</b>			<b>\$899.60</b>	

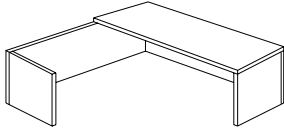

<b>Right L Unit Transaction Counter</b>				
<b>MV 8466 TCL R</b>	<b>Front 1466 TC</b> Transaction Counter	depth	14	<b>\$535.60</b>
		width	66	
		height	14	
		KD weight *	57	
		cubic feet	2.543	
		cubic meter	0.072	
		<b>Side 84 CL R</b>		
Right L Transaction Counter				
depth	84			
width	13			
height	14			
KD weight *	47			
cubic feet	2.578			
cubic meter	0.073			
<b>Unit Total :</b>			<b>\$899.60</b>	

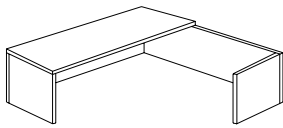

Model	Description	Dimension	List Price
-------	-------------	-----------	------------

**Left L Unit Transaction Counter**

MV 7872 TCL L

**Front 1472 TC**  
Transaction Counter

depth	14
width	72
height	14
KD weight *	66
cubic feet	2.755
cubic meter	0.078

**\$572.00**

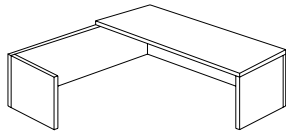

**Side 78 CL L**  
Left L Transaction Counter

depth	78
width	13
height	14
KD weight *	41
cubic feet	2.225
cubic meter	0.063

**\$338.00**

**Unit Total :**

**\$910.00**

**Right L Unit Transaction Counter**

MV 7872 TCL R

**Front 1472 TC**  
Transaction Counter

depth	14
width	72
height	14
KD weight *	66
cubic feet	2.755
cubic meter	0.078

**\$572.00**

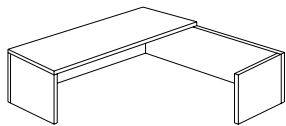

**Side 78 CL R**  
Right L Transaction Counter

depth	78
width	13
height	14
KD weight *	41
cubic feet	2.225
cubic meter	0.063

**\$338.00**

**Unit Total :**

**\$910.00**

\* This weight does not include Pallet weight

Model	Description	Dimension	List Price
-------	-------------	-----------	------------

**Left L Unit Transaction Counter**

MV 7866 TCL L

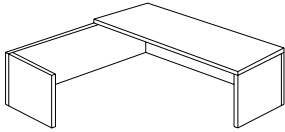

**Front 1466 TC**  
Transaction Counter

depth	14
width	66
height	14
KD weight *	57
cubic feet	2.543
cubic meter	0.072

**\$535.60**

**Side 78 CL R**  
Left L Transaction Counter

depth	78
width	13
height	14
KD weight *	41
cubic feet	2.225
cubic meter	0.063

**\$338.00**

**Unit Total : \$873.60**

**Right L Unit Transaction Counter**

MV 7866 TCL R

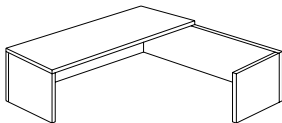

**Front 1466 TC**  
Transaction Counter

depth	14
width	66
height	14
KD weight *	57
cubic feet	2.543
cubic meter	0.072

**\$535.60**

**Side 78 CL R**  
Right L Transaction Counter

depth	78
width	13
height	14
KD weight *	41
cubic feet	2.225
cubic meter	0.063

**\$338.00**

**Unit Total : \$873.60**

\* This weight does not include Pallet weight

Model	Description	Dimension	List Price
-------	-------------	-----------	------------

**Left L Unit Glass Transaction Counter**

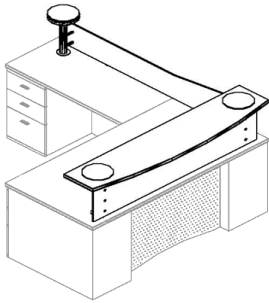

**MV 8472 TCG L**  
Left Transaction Glass Counter

depth	84
width	72
height	13
KD weight *	227
cubic feet	7.628
cubic meter	0.216

**\$1,088.88**

**Right L Unit Glass Transaction Counter**

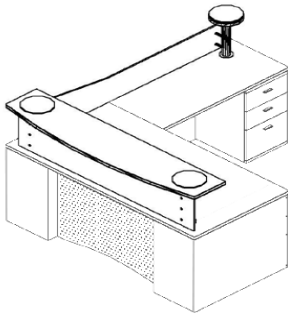

**MV 8472 TCG R**  
Right Transaction Glass Counter

depth	84
width	72
height	13
KD weight *	227
cubic feet	7.628
cubic meter	0.216

**\$1,088.88**

**Left L Unit Glass Transaction Counter**

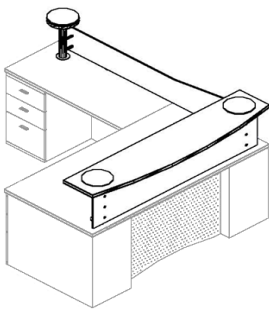

**MV 7872 TCG L**  
Left Transaction Glass Counter

depth	78
width	72
height	13
KD weight *	219
cubic feet	7.487
cubic meter	0.212

**\$1,076.40**

**Right L Unit Glass Transaction Counter**

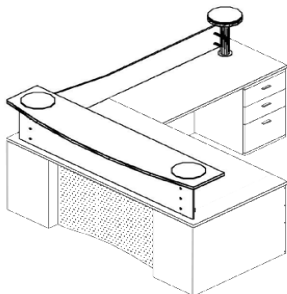

**MV 7872 TCG R**  
Right Transaction Glass Counter

depth	78
width	72
height	13
KD weight *	219
cubic feet	7.487
cubic meter	0.212

**\$1,076.40**

\* This weight does not include Pallet weight

Model	Description	Dimension	List Price
-------	-------------	-----------	------------

**Left L Unit Glass Transaction Counter**

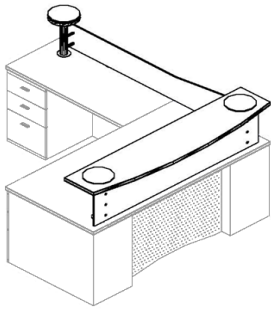

**MV 8466 TCG L**  
Left Transaction Glass Counter

depth	84
width	66
height	13
KD weight *	219
cubic feet	7.165
cubic meter	0.203

**\$1,056.64**

**Right L Unit Glass Transaction Counter**

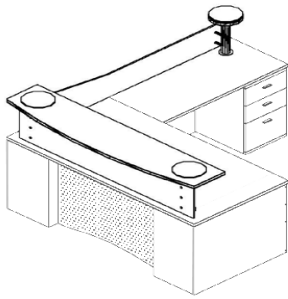

**MV 8466 TCG R**  
Right Transaction Glass Counter

depth	84
width	66
height	13
KD weight *	219
cubic feet	7.165
cubic meter	0.203

**\$1,056.64**

**Left L Unit Glass Transaction Counter**

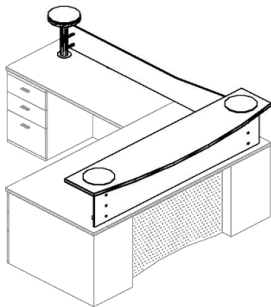

**MV 7866 TCG L**  
Left Transaction Glass Counter

depth	78
width	66
height	13
KD weight *	212
cubic feet	7.028
cubic meter	0.199

**\$1,045.20**

**Right L Unit Glass Transaction Counter**

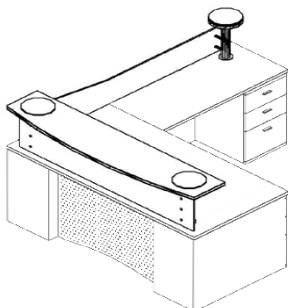

**MV 7866 TCG R**  
Right Transaction Glass Counter



depth	78
width	66
height	13
KD weight *	212
cubic feet	7.028
cubic meter	0.199

**\$1,045.20**

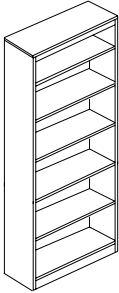
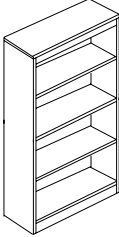
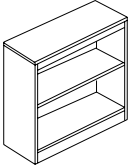
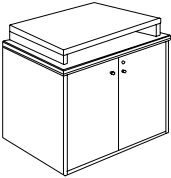
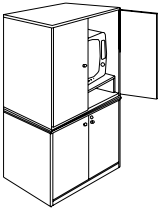
\* This weight does not include Pallet weight

Model	Description	Dimension		List Price
<b>MV 3672 BC</b> 	<b>Bookcases</b>	depth	12	<b>\$696.80</b>
		width	36	
		height	72	
		KD Weight *	112	
		cubic feet	5.192	
		cubic meter	0.147	
<b>MV 3648 BC</b> 	<b>Bookcases</b>	depth	12	<b>\$509.60</b>
		width	36	
		height	48	
		KD Weight *	79	
		cubic feet	3.532	
		cubic meter	0.100	
<b>MV 3630 BC</b> 	<b>Bookcases</b>	depth	12	<b>\$322.40</b>
		width	36	
		height	30	
		KD Weight *	53	
		cubic feet	2.331	
		cubic meter	0.066	
<b>MV 2436 LAV</b> 	<b>Low AV Cabinet</b>	depth	24	<b>\$1,154.40</b>
		width	36	
		height	42	
		KD weight *	172	
		cubic feet	6.781	
		cubic meter	0.192	
<b>MV 2436 HAV</b> 	<b>High AV Cabinet</b>	depth	24	<b>\$2,215.20</b>
		width	36	
		height	72	
		KD weight *	284	
		cubic feet	11.619	
		cubic meter	0.329	

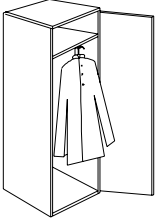
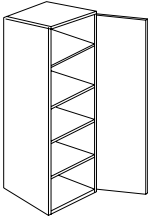
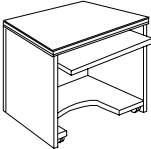
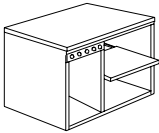
\* This weight does not include Pallet weight

Model	Description	Dimension		List Price
<b>MV 2418 HWC</b> 	<b>High Wardrobe Cabinet</b>	depth	24	<b>\$1,170.00</b>
		width	18	
		height	72	
		KD weight *	142	
		cubic feet	1.800	
		cubic meter	0.510	
<b>MV 2418 HSC</b> 	<b>High Storage Cabinet</b>	depth	24	<b>\$1,336.40</b>
		width	18	
		height	72	
		KD weight *	162	
		cubic feet	5.333	
		cubic meter	0.151	
<b>MV 2436 CPS</b> 	<b>Computer / Printer Stand</b>	depth	24	<b>\$696.80</b>
		width	36	
		height	30	
		KD Weight *	99	
		cubic feet	4.026	
		cubic meter	0.114	
<b>MV 2436 TP</b> 	<b>Technology Pedestal</b>	depth	24	<b>\$728.00</b>
		width	36	
		height	30	
		KD weight *	172	
		cubic feet	6.781	
		cubic meter	0.192	
<b>MV 2415 MBF</b> 	<b>Mobile Pedestal</b>	depth	24	<b>\$644.80</b>
		width	16	
		height	30	
		KD weight *	88	
		cubic feet	7.205	
		cubic meter	0.204	

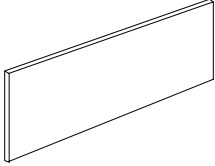
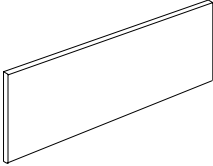
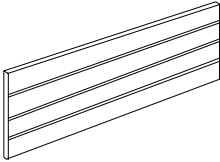
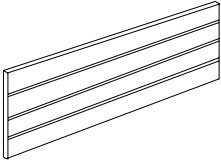
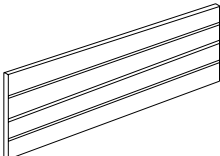

\* This weight does not include Pallet weight

Model	Description	Dimension	List Price
<b>TB 72</b>	<b>Tack Board</b>	depth width 70 height 16 KD weight *	<b>\$452.40</b>
			
<b>TB 66</b>	<b>Tack Board</b>	depth width 64 height 16 KD weight *	<b>\$442.00</b>
			
<b>SW 72</b>	<b>Slatwall Plastic Toolbar</b>	depth width height KD weight *	<b>\$93.60</b>
			
<b>SW 66</b>	<b>Slatwall Plastic Toolbar</b>	depth width height KD weight *	<b>\$88.40</b>
			
<b>SW 30</b>	<b>Slatwall Plastic Toolbar</b>	depth width height KD weight *	<b>\$46.80</b>
			

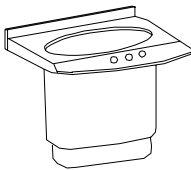
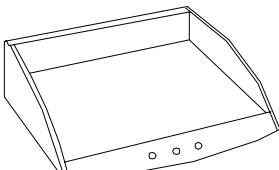
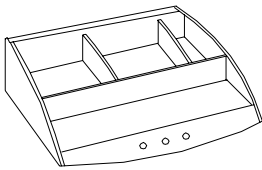
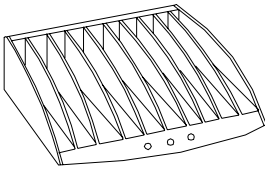
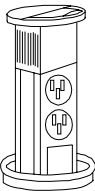

\* This weight does not include Pallet weight

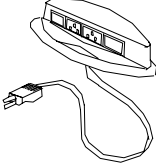
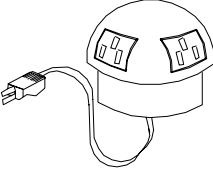
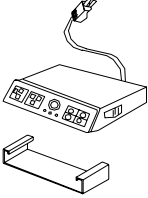
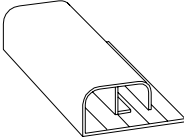
Model	Description	Dimension	List Price
SUH1	Slatwall Utensil Holder	depth width height KD weight *	<b>\$20.80</b>
			
SPT1	Slatwall Paper Tray	depth width height KD weight *	<b>\$46.80</b>
			
SAT 1	Slatwall Accessory Tray	depth width height KD weight *	<b>\$46.80</b>
			
SCD 1	Slatwall CD Holder	depth width height KD weight *	<b>\$36.40</b>
			
PDCR1	Retractable Power / Data Center	depth width height KD weight *	<b>\$530.40</b>
			

\* This weight does not include Pallet weight

Model	Description	Dimension		List Price
<b>PDCT1</b> 	<b>Work Surface Power / Data Center</b>	depth width height KD weight *		<b>\$530.40</b>
<b>PDCT2</b> 	<b>Work Surface Power / Data Pod</b>	depth width height KD weight *		<b>\$520.00</b>
<b>PDCU1</b> 	<b>Under Top Power / Data Director</b>	depth width height KD weight *		<b>\$166.40</b>
<b>RW1</b> 	<b>Wire Management Race Way</b>	length 1-ft width 1.18" height 2.36" KD weight *	<b>\$8.32</b>	
<b>TG1</b> 	<b>Work Surface Grommet</b>	depth width height KD weight *		<b>\$20.80</b>

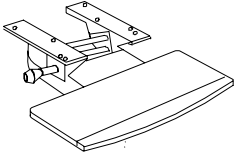
\* This weight does not include Pallet weight

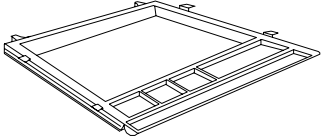
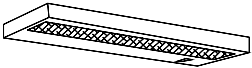
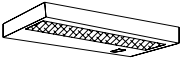
Model	Description	Dimension		List Price
<b>26187 VKT</b> 	<b>Keyboard Tray</b> - Medium Density Fiberboard tray - Features 21-3/4" width for ample keyboard space - Soft-touch black vinyl covering	depth	11	<b>\$364.00</b>
		width	21-3/4	
<b>26188 VMP</b> 	<b>Mouse Platform</b> - Steel, Black Powdercoat - For left or right hand operation	depth	8-3/8	<b>\$109.20</b>
		width	8-3/8	
<b>89710 CD</b> 	<b>Central Drawer</b> - Wide pencil drawer - With ball bearing slides - Black color, for use with any desk	depth	18	<b>\$119.60</b>
		width	23	
<b>48 TL</b> 	<b>Task light</b>	depth	7	<b>\$260.00</b>
		width	48	
		height	2	
<b>24 TL</b> 	<b>Task light</b>	depth	7	<b>\$234.00</b>
		width	24	
		height	2	

\* This weight does not include Pallet weight