

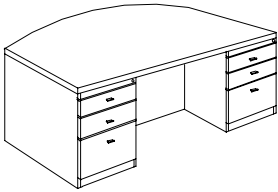
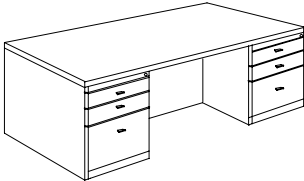
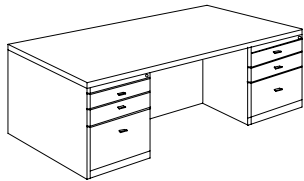
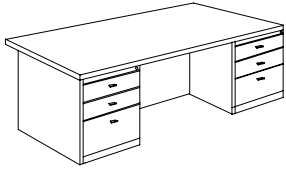

Model	Description	Dimension		List Price
ML 4272 BD 	Double Pedestal Executive - Bow Top Desk	depth 42 width 72 height 30 KD Weight * 331 cubic feet 27.758 cubic meter 0.781		\$1,383.20
ML 3672 ED 	Double Pedestal Executive Desk	depth 36 width 72 height 30 KD Weight * 320 cubic feet 27.088 cubic meter 0.767		\$1,352.00
ML 3666 ED 	Double Pedestal Executive Desk	depth 36 width 66 height 30 KD Weight * 310 cubic feet 26.699 cubic meter 0.756		\$1,326.00
ML 3066 ED 	Double Pedestal Executive Desk 24" X 66" Chassis with 30" X 66" Worksurface	depth 30 width 66 height 30 KD Weight * 252 cubic feet 18.894 cubic meter 0.535		\$1,196.00

* This weight does not include Pallet weight

Model	Description	Dimension		List Price
ML 2472 SCM 	Storage Credenza	depth	24	\$1,539.20
		width	72	
		height	30	
		KD Weight *	352	
		cubic feet	22.956	
		cubic meter	0.650	
ML 2466 SCM 	Storage Credenza	depth	24	\$1,476.80
		width	66	
		height	30	
		KD Weight *	323	
		cubic feet	21.649	
		cubic meter	0.613	
ML 2472 KC 	Knee Space Credenza (also available with BBF Pedestals)	depth	24	\$1,118.00
		width	72	
		height	30	
		KD Weight *	236	
		cubic feet	18.824	
		cubic meter	0.533	
ML 2466 KC 	Knee Space Credenza (also available with BBF Pedestals)	depth	24	\$1,086.80
		width	66	
		height	30	
		KD Weight *	228	
		cubic feet	18.471	
		cubic meter	0.523	
ML 2472 DCC 	Four Door Credenza	depth	24	\$1,175.20
		width	72	
		height	30	
		KD Weight *	278	
		cubic feet	10.560	
		cubic meter	0.299	
ML 2472 CFC 	Cabinet Lateral Credenza	depth	24	\$1,232.40
		width	72	
		height	30	
		KD Weight *	295	
		cubic feet	22.461	
		cubic meter	0.636	

* This weight does not include Pallet weight

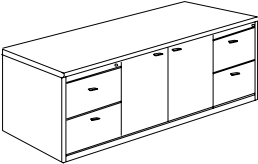
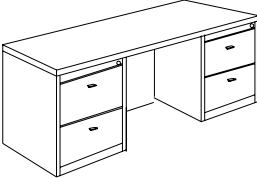
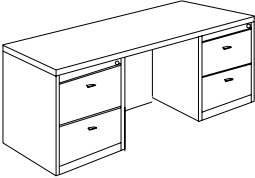
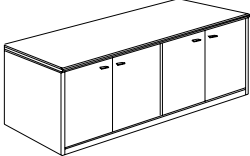
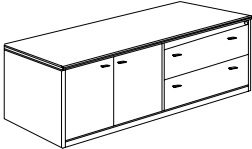
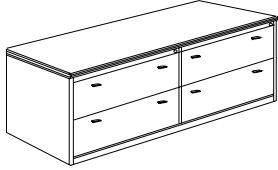
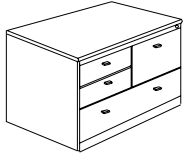
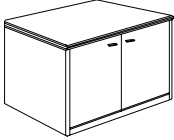
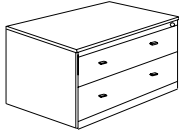
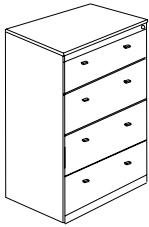
Model	Description	Dimension		List Price
ML 2472 DFC 	Lateral File Credenza	depth	24	\$1,487.20
		width	72	
		height	30	
		KD Weight *	313	
		cubic feet	34.363	
		cubic meter	0.973	
ML 2436 CP 	Combo Pedestal with 24" x 36" Top	depth	24	\$858.00
		width	36	
		height	30	
		KD Weight *	196	
		cubic feet	17.234	
		cubic meter	0.488	
ML 2436 DC 	Two Door Cabinet with 24" x 36" Top	depth	24	\$488.80
		width	36	
		height	30	
		KD Weight *	141	
		cubic feet	5.333	
		cubic meter	0.151	
ML 2436 LF 	Lateral File	depth	24	\$748.80
		width	36	
		height	30	
		KD Weight *	159	
		cubic feet	17.234	
		cubic meter	0.488	
ML 2436 FDLF 	4 Drawer Lateral File	depth	24	\$1,310.40
		width	36	
		height	55	
		KD Weight *	273	
		cubic feet	31.114	
		cubic meter	0.881	

* This weight does not include Pallet weight

Model	Description	Dimension		List Price
ML 4272 BSL	Left Pedestal Executive Bow Top Desk	depth	42	\$1,086.80
		width	72	
		height	30	
		KD Weight *	278	
		cubic feet	24.792	
		cubic meter	0.702	

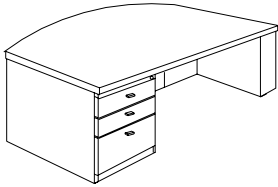

ML 4272 BSR	Right Pedestal Executive Bow Top Desk	depth	42	\$1,086.80
		width	72	
		height	30	
		KD Weight *	278	
		cubic feet	24.792	
		cubic meter	0.702	



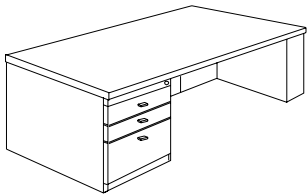

ML 3672 ESL	Left Pedestal Executive Desk	depth	36	\$1,055.60
		width	72	
		height	30	
		KD Weight *	267	
		cubic feet	24.298	
		cubic meter	0.688	

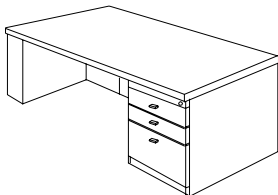

ML 3672 ESR	Right Pedestal Executive Desk	depth	36	\$1,055.60
		width	72	
		height	30	
		KD Weight *	267	
		cubic feet	24.298	
		cubic meter	0.688	

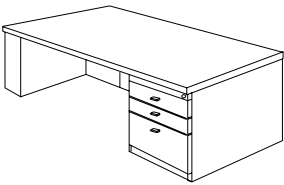

* This weight does not include Pallet weight

Model	Description	Dimension		List Price
ML 3666 ESL	Left Pedestal Executive Desk	depth	36	\$1,029.60
	width	66		
	height	30		
	KD Weight *	257		
	cubic feet	23.909		
	cubic meter	0.677		
	ML 3666 ESR	Right Pedestal Executive Desk	depth	36
	width	66		
	height	30		
	KD Weight *	257		
	cubic feet	23.909		
	cubic meter	0.677		
	ML 3066 ESL	Left Pedestal Executive Desk 24" X 66" Chassis with 30" X 66" Worksurface	depth	30
	width	66		
	height	30		
	KD Weight *	211		
	cubic feet	16.881		
	cubic meter	0.478		
	ML 3066 ESR	Right Pedestal Executive Desk 24" X 66" Chassis with 30" X 66" Worksurface	depth	30
	width	66		
	height	30		
	KD Weight *	211		
	cubic feet	16.881		
	cubic meter	0.478		

* This weight does not include Pallet weight

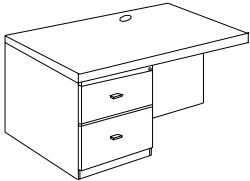
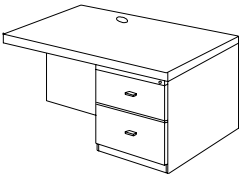
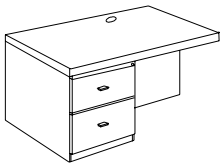
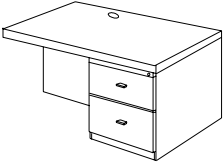
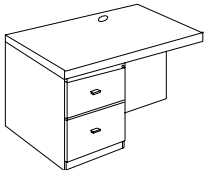
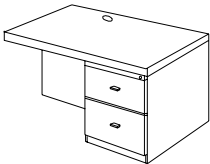
Model	Description	Dimension		List Price
ML 48 RL 	Executive 48" Left Return	depth	24	\$618.80
		width	48	
height	30			
KD Weight *	137			
cubic feet	10.101			
cubic meter	0.286			
ML 48 RR 	Executive 48" Right Return	depth	24	\$618.80
		width	48	
height	30			
KD Weight *	137			
cubic feet	10.101			
cubic meter	0.286			
ML 42 RL 	Executive 42" Left Return	depth	24	\$598.00
		width	42	
height	30			
KD Weight *	129			
cubic feet	9.783			
cubic meter	0.277			
ML 42 RR 	Executive 42" Right Return	depth	24	\$598.00
		width	42	
height	30			
KD Weight *	129			
cubic feet	9.783			
cubic meter	0.277			
ML 36 RL 	Executive 36" Left Return	depth	24	\$582.40
		width	36	
height	30			
KD Weight *	120			
cubic feet	9.465			
cubic meter	0.268			
ML 36 RR 	Executive 36" Right Return	depth	24	\$582.40
		width	36	
height	30			
KD Weight *	120			
cubic feet	9.465			
cubic meter	0.268			

* This weight does not include Pallet weight

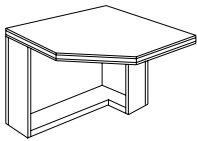
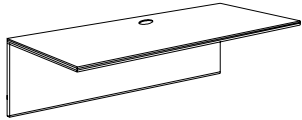
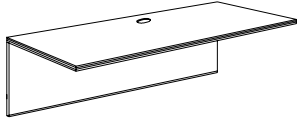
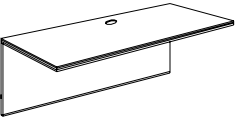
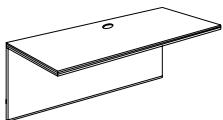
Model	Description	Dimension		List Price
ML 3636 CU	Corner Unit	depth	36	\$369.20
		width	36	
		height	30	
		KD Weight *	93	
		cubic feet	10.206	
		cubic meter	0.289	
	ML 48 EB	Executive 48" Bridge	depth	24
		width	48	
		height	30	
		KD Weight *	69	
		cubic feet	2.825	
		cubic meter	0.080	
	ML 42 EB	Executive 42" Bridge	depth	24
		width	42	
		height	30	
		KD Weight *	62	
		cubic feet	2.507	
		cubic meter	0.071	
	ML 36 EB	Executive 36" Bridge	depth	24
		width	36	
		height	30	
		KD Weight *	53	
		cubic feet	1.190	
		cubic meter	0.062	
	ML 30 EB	Executive 30" Bridge	depth	24
		width	30	
		height	30	
		KD Weight *	44	
		cubic feet	1.872	
		cubic meter	0.053	

* This weight does not include Pallet weight

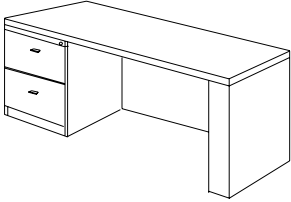
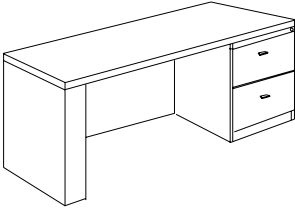
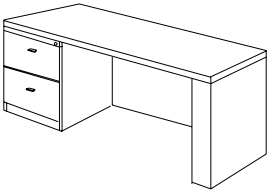
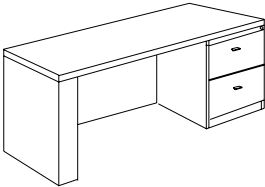
Model	Description	Dimension		List Price
ML 2472 CL	Left Pedestal Credenza	depth	24	\$910.00
		width	72	
		height	30	
		KD Weight *	209	
		cubic feet	19.707	
		cubic meter	0.558	
	ML 2472 CR	Right Pedestal Credenza	depth	24
		width	72	
		height	30	
		KD Weight *	209	
		cubic feet	19.707	
		cubic meter	0.558	
	MV 2466 CL	Left Pedestal Credenza	depth	24
		width	66	
		height	30	
		KD Weight *	201	
		cubic feet	19.353	
		cubic meter	0.548	
	ML 2466 CR	Right Pedestal Credenza	depth	24
		width	66	
		height	30	
		KD Weight *	201	
		cubic feet	19.353	
		cubic meter	0.548	

* This weight does not include Pallet weight

Model	Description	Dimension		List Price
ML 2472 CBL	Left Pedestal Credenza with 24" Deep BBF	depth	24	\$1,003.60
	width	72		
	height	30		
	KD Weight *	236		
	cubic feet	23.380		
	cubic meter	0.662		
	ML 2472 CBR	Right Pedestal Credenza with 24" Deep BBF	depth	24
	width	72		
	height	30		
	KD Weight *	236		
	cubic feet	23.380		
	cubic meter	0.662		
	ML 2466 CBL	Left Pedestal Credenza with 24" Deep BBF	depth	24
	width	66		
	height	30		
	KD Weight *	228		
	cubic feet	23.026		
	cubic meter	0.652		
	ML 2466 CBR	Right Pedestal Credenza with 24" Deep BBF	depth	24
	width	66		
	height	30		
	KD Weight *	228		
	cubic feet	23.026		
	cubic meter	0.652		

* This weight does not include Pallet weight

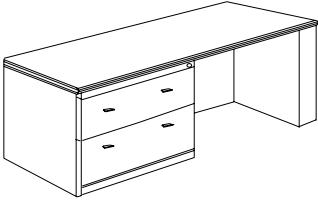
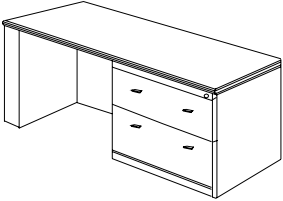
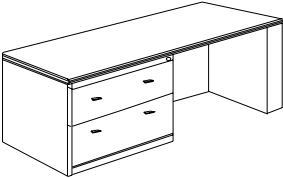
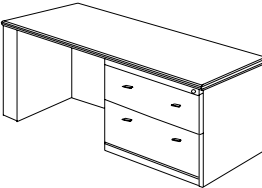
Model	Description	Dimension		List Price
ML 2472 SFCL	Left Single Lateral File Credenza	depth	24	\$1,112.80
		width	72	
	height	30		
	KD Weight *	248		
	cubic feet	27.476		
	cubic meter	0.778		
ML 2472 SFCR	Right Single Lateral File Credenza	depth	24	\$1,112.80
		width	72	
	height	30		
	KD Weight *	248		
	cubic feet	27.476		
	cubic meter	0.778		
ML 2466 SFCL	Left Single Lateral File Credenza	depth	24	\$1,081.60
		width	66	
	height	30		
	KD Weight *	240		
	cubic feet	27.123		
	cubic meter	0.768		
ML 2466 SFCR	Right Single Lateral File Credenza	depth	24	\$1,081.60
		width	66	
	height	30		
	KD Weight *	240		
	cubic feet	27.123		
	cubic meter	0.768		

* This weight does not include Pallet weight

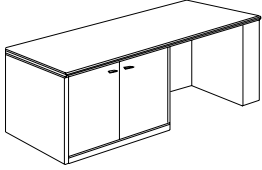
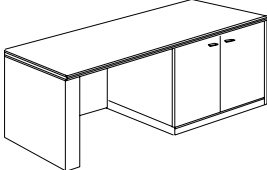
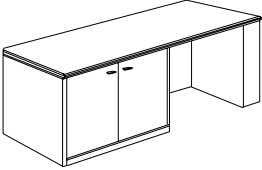
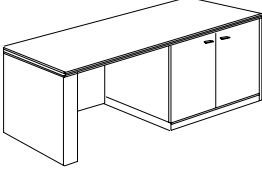
Model	Description	Dimension		List Price
ML 2472 SCCL 	Left Single Cabinet Credenza	depth 24 width 72 height 30 KD Weight * 230 cubic feet 15.575 cubic meter 0.441	\$852.80	
ML 2472 SCCR 	Right Single Cabinet Credenza	depth 24 width 72 height 30 KD Weight * 230 cubic feet 15.575 cubic meter 0.441		\$852.80
ML 2466 SCCL 	Left Single Cabinet Credenza	depth 24 width 66 height 30 KD Weight * 223 cubic feet 15.221 cubic meter 0.431	\$821.60	
ML 2466 SCCR 	Right Single Cabinet Credenza	depth 24 width 66 height 30 KD Weight * 223 cubic feet 15.221 cubic meter 0.431		\$821.60

* This weight does not include Pallet weight

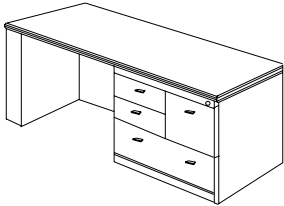
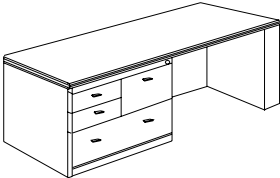
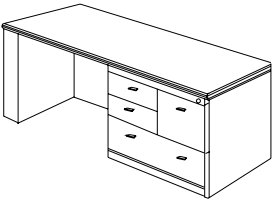
Model	Description	Dimension		List Price
ML 2472 CPCL	Left Combo Pedestal Credenza	depth	24	\$1,222.00
		width	72	
		height	30	
		KD Weight *	286	
		cubic feet	27.476	
		cubic meter	0.778	
ML 2472 CPR	Right Combo Pedestal Credenza	depth	24	\$1,222.00
		width	72	
		height	30	
		KD Weight *	286	
		cubic feet	27.476	
		cubic meter	0.778	
ML 2466 CPCL	Left Combo Pedestal Credenza	depth	24	\$1,190.80
		width	66	
		height	30	
		KD Weight *	278	
		cubic feet	27.123	
		cubic meter	0.768	
ML 2466 CPR	Right Combo Pedestal Credenza	depth	24	\$1,190.80
		width	66	
		height	30	
		KD Weight *	278	
		cubic feet	27.123	
		cubic meter	0.768	

* This weight does not include Pallet weight

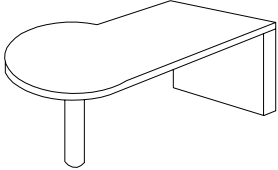
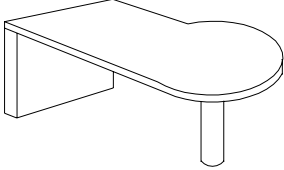
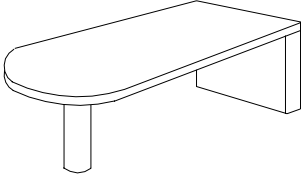
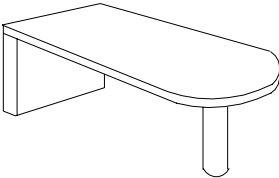
Model	Description	Dimension	List Price		
ML 4272 PTL	Left Executive P-Top Desk	depth	42		
		width	72		
		height	30		
		KD Weight *	191		
		cubic feet	10.418		
		cubic meter	0.295		
					\$682.24
ML 4272 PTR	Right Executive P-Top Desk	depth	42		
		width	72		
		height	30		
		KD Weight *	191		
		cubic feet	10.418		
		cubic meter	0.295		
					\$682.24
ML 3672 BTL	Left Executive Bullet Top Desk	depth	36		
		width	72		
		height	30		
		KD Weight *	184		
		cubic feet	9.924		
		cubic meter	0.281		
					\$650.00
ML 3672 BTR	Right Executive Bullet Top Desk	depth	36		
		width	72		
		height	30		
		KD Weight *	184		
		cubic feet	9.924		
		cubic meter	0.281		
					\$650.00

* This weight does not include Pallet weight

Model	Description	Dimension	List Price
-------	-------------	-----------	------------

Left Executive Bow Top "U" Unit

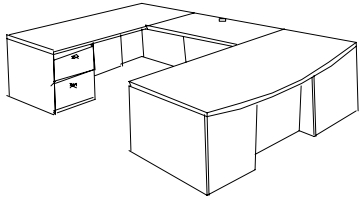

ML 4272 BSR Right Pedestal Executive Bow Top Desk	depth	42	\$1,086.80
	width	72	
	height	30	
	KD weight *	278	
	cubic feet	24.792	
	cubic meter	0.702	
ML 48 EB Executive 48" Bridge	depth	24	\$213.20
	width	48	
	height	30	
	KD weight *	69	
	cubic feet	2.825	
	cubic meter	0.080	
ML 2472 CL Left Pedestal Credenza (For Optional Credenzas, please see page 14 to 18)	depth	24	\$910.00
	width	72	
	height	30	
	KD weight *	209	
	cubic feet	19.707	
	cubic meter	0.558	
Unit Total :			\$2,210.00

Right Executive Bow Top "U" Unit

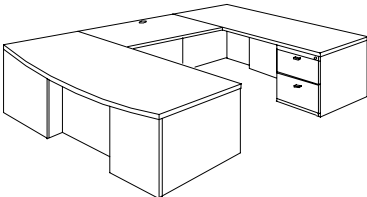

ML 4272 BSL Left Pedestal Executive Bow Top Desk	depth	42	\$1,086.80
	width	72	
	height	30	
	KD weight *	278	
	cubic feet	24.792	
	cubic meter	0.702	
ML 48 EB Executive 48" Bridge	depth	24	\$213.20
	width	48	
	height	30	
	KD weight *	69	
	cubic feet	2.825	
	cubic meter	0.080	
ML 2472 CR Right Pedestal Credenza (For Optional Credenzas, please see page 14 to 18)	depth	24	\$910.00
	width	72	
	height	30	
	KD weight *	209	
	cubic feet	19.707	
	cubic meter	0.558	
Unit Total :			\$2,210.00

* This weight does not include Pallet weight

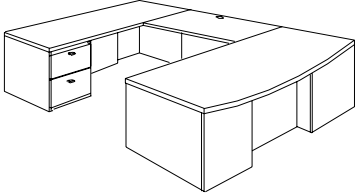
Model	Description	Dimension		List Price	
Left Executive Bow Top "U" Unit					
	ML 4272 BSR Right Pedestal Executive Bow Top Desk	depth	42	\$1,086.80	
		width	72		
		height	30		
		KD weight *	278		
		cubic feet	24.792		
		cubic meter	0.702		
		ML 42 EB Executive 42" Bridge	depth	24	\$197.60
		width	42		
		height	30		
		KD weight *	62		
	cubic feet	2.507			
	cubic meter	0.071			
	ML 2472 CL Left Pedestal Credenza (For Optional Credenzas, please see page 14 to 18)	depth	24	\$910.00	
	width	72			
	height	30			
	KD weight *	209			
	cubic feet	19.707			
	cubic meter	0.558			
	Unit Total :			\$2,194.40	

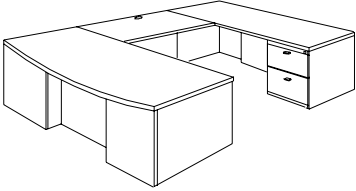
Right Executive Bow Top "U" Unit					
	ML 4272 BSL Left Pedestal Executive Bow Top Desk	depth	42	\$1,086.80	
		width	72		
		height	30		
		KD weight *	278		
		cubic feet	24.792		
		cubic meter	0.702		
		ML 42 EB Executive 42" Bridge	depth	24	\$197.60
		width	42		
		height	30		
		KD weight *	62		
	cubic feet	2.507			
	cubic meter	0.071			
	ML 2472 CR Right Pedestal Credenza (For Optional Credenzas, please see page 14 to 18)	depth	24	\$910.00	
	width	72			
	height	30			
	KD weight *	209			
	cubic feet	19.707			
	cubic meter	0.558			
	Unit Total :			\$2,194.40	

* This weight does not include Pallet weight

Model	Description	Dimension	List Price
-------	-------------	-----------	------------

Left Executive "U" Unit

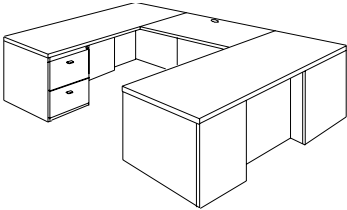

ML 3672 ESR Right Pedestal Executive Desk	depth	36	\$1,055.60
	width	72	
	height	30	
	KD weight *	267	
	cubic feet	27.088	
	cubic meter	0.767	

ML 48 EB Executive 48" Bridge	depth	24	\$213.20
	width	48	
	height	30	
	KD weight *	69	
	cubic feet	2.437	
	cubic meter	0.069	

ML 2472 CL Left Pedestal Credenza (For Optional Credenzas, please see page 14 to 18)	depth	24	\$910.00
	width	72	
	height	30	
	KD weight *	209	
	cubic feet	19.707	
	cubic meter	0.558	

Unit Total : \$2,178.80

Right Executive "U" Unit

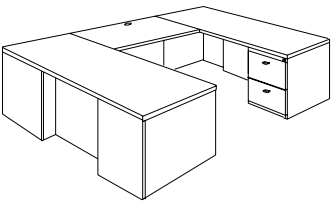

ML 3672 ESL Left Pedestal Executive Desk	depth	36	\$1,055.60
	width	72	
	height	30	
	KD weight *	267	
	cubic feet	27.088	
	cubic meter	0.767	

ML 48 EB Executive 48" Bridge	depth	24	\$213.20
	width	48	
	height	30	
	KD weight *	69	
	cubic feet	2.437	
	cubic meter	0.069	

ML 2472 CR Right Pedestal Credenza (For Optional Credenzas, please see page 14 to 18)	depth	24	\$910.00
	width	72	
	height	30	
	KD weight *	209	
	cubic feet	19.707	
	cubic meter	0.558	

Unit Total : \$2,178.80

* This weight does not include Pallet weight

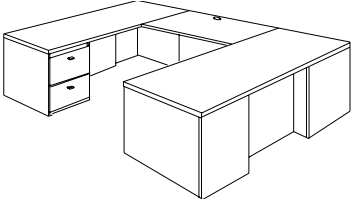
Model	Description	Dimension	List Price
Left Executive "U" Unit			
	ML 3672 ESR Right Pedestal Executive Desk	depth 36 width 72 height 30 KD weight * 267 cubic feet 27.088 cubic meter 0.767	\$1,055.60
	ML 42 EB Executive 42" Bridge	depth 24 width 42 height 30 KD weight * 62 cubic feet 2.507 cubic meter 0.071	\$197.60
	ML 2472 CL Left Pedestal Credenza (For Optional Credenzas, please see page 14 to 18)	depth 24 width 72 height 30 KD weight * 209 cubic feet 19.707 cubic meter 0.558	\$910.00
	Unit Total :		\$2,163.20

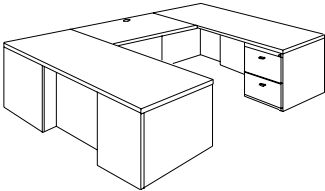
Right Executive "U" Unit			
	ML 3672 ESL Left Pedestal Executive Desk	depth 36 width 72 height 30 KD weight * 267 cubic feet 27.088 cubic meter 0.767	\$1,055.60
	ML 42 EB Executive 42" Bridge	depth 24 width 42 height 30 KD weight * 62 cubic feet 2.507 cubic meter 0.071	\$197.60
	ML 2472 CR Right Pedestal Credenza (For Optional Credenzas, please see page 14 to 18)	depth 24 width 72 height 30 KD weight * 209 cubic feet 19.707 cubic meter 0.558	\$910.00
	Unit Total :		\$2,163.20

Model	Description	Dimension	List Price
-------	-------------	-----------	------------

Left Executive "U" Unit

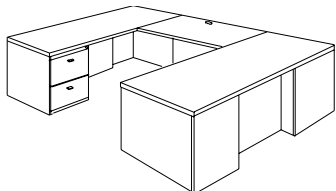

ML 3666 ESR Right Pedestal Executive Desk	depth	36	\$1,029.60
	width	66	
	height	30	
	KD weight *	257	
	cubic feet	26.699	
	cubic meter	0.756	

ML 48 EB Executive 48" Bridge	depth	24	\$213.20
	width	48	
	height	30	
	KD weight *	69	
	cubic feet	2.437	
	cubic meter	0.069	

ML 2466 CL Left Pedestal Credenza (For Optional Credenzas, please see page 14 to 18)	depth	24	\$878.80
	width	66	
	height	30	
	KD weight *	201	
	cubic feet	19.707	
	cubic meter	0.558	

Unit Total : \$2,121.60

Right Executive "U" Unit

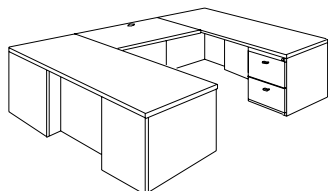

ML 3666 ESL Left Pedestal Executive Desk	depth	36	\$1,029.60
	width	66	
	height	30	
	KD weight *	257	
	cubic feet	26.699	
	cubic meter	0.756	

ML 48 EB Executive 48" Bridge	depth	24	\$213.20
	width	48	
	height	30	
	KD weight *	69	
	cubic feet	2.437	
	cubic meter	0.069	

ML 2466 CR Right Pedestal Credenza (For Optional Credenzas, please see page 14 to 18)	depth	24	\$878.80
	width	66	
	height	30	
	KD weight *	201	
	cubic feet	16.281	
	cubic meter	0.461	

Unit Total : \$2,121.60

* This weight does not include Pallet weight

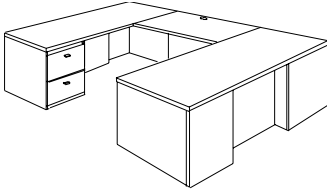
Model	Description	Dimension	List Price
Left Executive Desk "U" Unit			
	ML 3666 ESR Right Pedestal Executive Desk	depth 36 width 66 height 30 KD weight * 257 cubic feet 26.699 cubic meter 0.756	\$1,029.60
	ML 42 EB Executive 42" Bridge	depth 24 width 42 height 30 KD weight * 62 cubic feet 2.507 cubic meter 0.071	\$197.60
	ML 2466 CL Left Pedestal Credenza (For Optional Credenzas, please see page 14 to 18)	depth 24 width 66 height 30 KD weight * 201 cubic feet 16.281 cubic meter 0.461	\$878.80
	Unit Total :		\$2,106.00

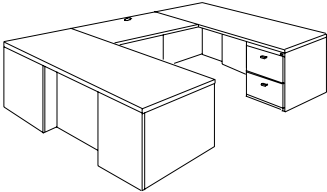
Right Executive "U" Unit			
	ML 3666 ESL Left Pedestal Executive Desk	depth 36 width 66 height 30 KD weight * 257 cubic feet 26.699 cubic meter 0.756	\$1,029.60
	ML 42 EB Executive 42" Bridge	depth 24 width 42 height 30 KD weight * 62 cubic feet 2.507 cubic meter 0.071	\$197.60
	ML 2466 CR Right Pedestal Credenza (For Optional Credenzas, please see page 14 to 18)	depth 24 width 66 height 30 KD weight * 201 cubic feet 16.281 cubic meter 0.461	\$878.80
			\$2,106.00

* This weight does not include Pallet weight

Model	Description	Dimension	List Price
-------	-------------	-----------	------------

Left Executive "U" Unit

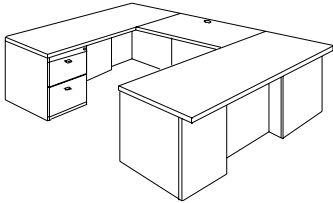

ML 3066 ESR	depth	30	\$915.20
Right Pedestal Executive Desk	width	66	
24" X 66" Chassis with 30" X 66" Worksurface	height	30	
	KD weight *	211	
	cubic feet	18.894	
	cubic meter	0.535	

ML 48 EB	depth	24	\$213.20
Executive 48" Bridge	width	48	
	height	30	
	KD weight *	69	
	cubic feet	2.437	
	cubic meter	0.069	

ML 2466 CL	depth	24	\$878.80
Left Pedestal Credenza	width	66	
(For Optional Credenzas, please see page 14 to 18)	height	30	
	KD weight *	201	
	cubic feet	16.281	
	cubic meter	0.461	

Unit Total : \$2,007.20

Right Executive "U" Unit

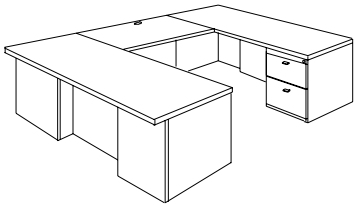

ML 3066 ESL	depth	30	\$915.20
Left Pedestal Executive Desk	width	66	
24" X 66" Chassis with 30" X 66" Worksurface	height	30	
	KD weight *	211	
	cubic feet	18.894	
	cubic meter	0.535	

ML 48 EB	depth	24	\$213.20
Executive 48" Bridge	width	48	
	height	30	
	KD weight *	69	
	cubic feet	2.437	
	cubic meter	0.069	

ML 2466 CR	depth	24	\$878.80
Right Pedestal Credenza	width	66	
(For Optional Credenzas, please see page 14 to 18)	height	30	
	KD weight *	201	
	cubic feet	16.281	
	cubic meter	0.461	

Unit Total : \$2,007.20

* This weight does not include Pallet weight

Model	Description	Dimension	List Price
-------	-------------	-----------	------------

Left Executive "U" Unit

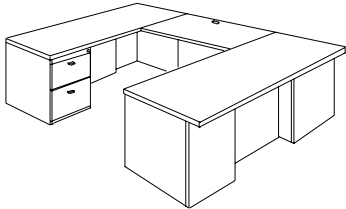

ML 3066 ESR	depth	30	\$915.20
Right Pedestal Executive Desk	width	66	
24" X 66" Chassis with 30" X 66" Worksurface	height	30	
	KD weight *	211	
	cubic feet	18.894	
	cubic meter	0.535	

ML 42 EB	depth	24	\$197.60
Executive 42" Bridge	width	42	
	height	30	
	KD weight *	62	
	cubic feet	2.507	
	cubic meter	0.071	

ML 2466 CL	depth	24	\$878.80
Left Pedestal Credenza	width	66	
(For Optional Credenzas, please see page 14 to 18)	height	30	
	KD weight *	201	
	cubic feet	16.281	
	cubic meter	0.461	

Unit Total : \$1,991.60

Right Executive "U" Unit

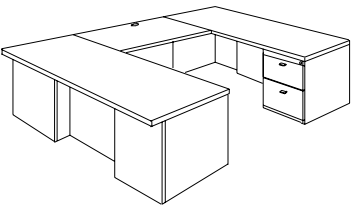

ML 3066 ESL	depth	30	\$915.20
Left Pedestal Executive Desk	width	66	
24" X 66" Chassis with 30" X 66" Worksurface	height	30	
	KD weight *	211	
	cubic feet	18.894	
	cubic meter	0.535	

ML 42 EB	depth	24	\$197.60
Executive 42" Bridge	width	42	
	height	30	
	KD weight *	62	
	cubic feet	2.507	
	cubic meter	0.071	

ML 2466 CR	depth	24	\$878.80
Right Pedestal Credenza	width	66	
(For Optional Credenzas, please see page 14 to 18)	height	30	
	KD weight *	201	
	cubic feet	16.281	
	cubic meter	0.461	

Unit Total : \$1,991.60

* This weight does not include Pallet weight

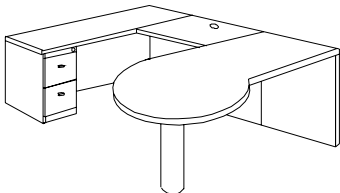
Model	Description	Dimension	List Price
Left Executive P "U" Unit			
	ML 4272 PTR Right Executive P Top Desk	depth 42 width 72 height 30 KD weight * 191 cubic feet 10.418 cubic meter 0.295	\$682.24
	ML 48 EB Executive 48" Bridge	depth 24 width 48 height 30 KD weight * 69 cubic feet 2.437 cubic meter 0.069	\$213.20
	ML 2472 CL Left Pedestal Credenza (For Optional Credenzas, please see page 14 to 18)	depth 24 width 72 height 30 KD weight * 209 cubic feet 19.707 cubic meter 0.558	\$910.00
	Unit Total :		\$1,805.44

Right Executive P "U" Unit

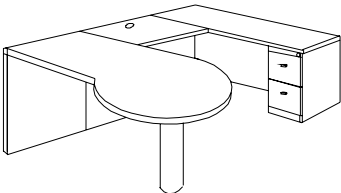
	ML 4272 PTL Left Executive P Top Desk	depth 42 width 72 height 30 KD weight * 191 cubic feet 10.418 cubic meter 0.295	\$682.24
	ML 48 EB Executive 48" Bridge	depth 24 width 48 height 30 KD weight * 69 cubic feet 2.437 cubic meter 0.069	\$213.20
	ML 2472 CR Right Pedestal Credenza (For Optional Credenzas, please see page 14 to 18)	depth 24 width 72 height 30 KD weight * 209 cubic feet 19.707 cubic meter 0.558	\$910.00
	Unit Total :		\$1,805.44

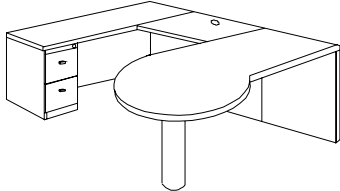
Model	Description	Dimension	List Price
Left Executive P "U" Unit			
	ML 4272 PTR	depth 42	\$682.24
	Right Executive P Top Desk	width 72	
		height 30	
		KD weight * 191	
		cubic feet 10.418	
		cubic meter 0.295	
	ML 42 EB	depth 24	\$197.60
	Executive 42" Bridge	width 42	
		height 30	
	KD weight * 62		
	cubic feet 2.507		
	cubic meter 0.071		
ML 2472 CL	depth 24	\$910.00	
Left Pedestal Credenza	width 72		
(For Optional Credenzas, please see page 14 to 18)	height 30		
	KD weight * 209		
	cubic feet 19.707		
	cubic meter 0.558		
	Unit Total :		\$1,789.84

Right Executive P "U" Unit

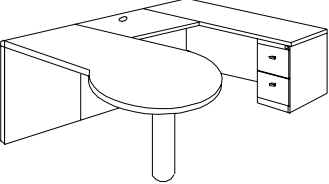
	ML 4272 PTL	depth 42	\$682.24
	Left Executive P Top Desk	width 72	
		height 30	
		KD weight * 191	
		cubic feet 8.582	
		cubic meter 0.243	
	ML 42 EB	depth 24	\$197.60
	Executive 42" Bridge	width 42	
		height 30	
	KD weight * 62		
	cubic feet 10.418		
	cubic meter 0.295		
ML 2472 CR	depth 24	\$910.00	
Right Pedestal Credenza	width 72		
(For Optional Credenzas, please see page 14 to 18)	height 30		
	KD weight * 209		
	cubic feet 19.707		
	cubic meter 0.558		
	Unit Total :		\$1,789.84

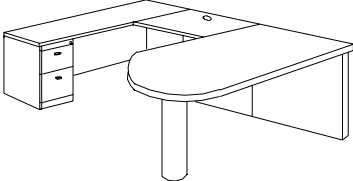
Model	Description	Dimension	List Price
Left Executive Bullet "U" Unit			
	ML 3672 BTR		
	Right Executive Bullet Top Desk	depth 36	\$650.00
		width 72	
		height 30	
		KD weight * 184	
		cubic feet 9.924	
		cubic meter 0.281	
	ML 48 EB		
	Executive 48" Bridge	depth 24	\$213.20
		width 48	
	height 30		
	KD weight * 69		
	cubic feet 2.437		
	cubic meter 0.069		
ML 2472 CL			
Left Pedestal Credenza	depth 24	\$910.00	
(For Optional Credenzas, please see page 14 to 18)	width 72		
	height 30		
	KD weight * 209		
	cubic feet 19.707		
	cubic meter 0.558		
	Unit Total :	\$1,773.20	

Right Executive Bullet "U" Unit

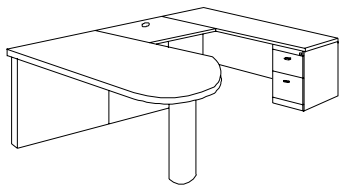

ML 3672 BTL			
Left Executive Bullet Top Desk	depth 36	\$650.00	
	width 72		
	height 30		
	KD weight * 184		
	cubic feet 9.924		
	cubic meter 0.281		
ML 48 EB			
Executive 48" Bridge	depth 24	\$213.20	
	width 48		
	height 30		
	KD weight * 69		
	cubic feet 2.437		
	cubic meter 0.069		
ML 2472 CR			
Right Pedestal Credenza	depth 24	\$910.00	
(For Optional Credenzas, please see page 14 to 18)	width 72		
	height 30		
	KD weight * 209		
	cubic feet 19.707		
	cubic meter 0.558		
	Unit Total :	\$1,773.20	

* This weight does not include Pallet weight

Model	Description	Dimension	List Price
-------	-------------	-----------	------------

Left Executive Bullet "U" Unit

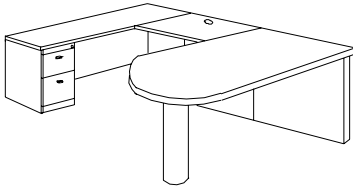

ML 3672 BTR Right Executive Bullet Top Desk	depth	36	\$650.00
	width	72	
	height	30	
	KD weight *	184	
	cubic feet	9.924	
	cubic meter	0.281	

ML 42 EB Executive 42" Bridge	depth	24	\$197.60
	width	42	
	height	30	
	KD weight *	62	
	cubic feet	2.507	
	cubic meter	0.071	

ML 2472 CL Left Pedestal Credenza (For Optional Credenzas, please see page 14 to 18)	depth	24	\$910.00
	width	72	
	height	30	
	KD weight *	209	
	cubic feet	19.707	
	cubic meter	0.558	

Unit Total : \$1,757.60

Right Executive Bullet "U" Unit

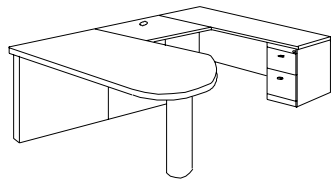

ML 3672 BTL Left Executive Bullet Top Desk	depth	36	\$650.00
	width	72	
	height	30	
	KD weight *	184	
	cubic feet	9.924	
	cubic meter	0.281	

ML 42 EB Executive 42" Bridge	depth	24	\$197.60
	width	42	
	height	30	
	KD weight *	62	
	cubic feet	2.507	
	cubic meter	0.071	

ML 2472 CR Right Pedestal Credenza (For Optional Credenzas, please see page 14 to 18)	depth	24	\$910.00
	width	72	
	height	30	
	KD weight *	209	
	cubic feet	19.707	
	cubic meter	0.558	

Unit Total : \$1,757.60

* This weight does not include Pallet weight

Model	Description	Dimension	List Price
-------	-------------	-----------	------------

Left Executive Bow Top "L" Unit

ML 4272 BSR
Right Pedestal Executive Bow Top Desk

depth	42	\$1,086.80
width	72	
height	30	
KD weight *	278	
cubic feet	24.792	
cubic meter	0.702	

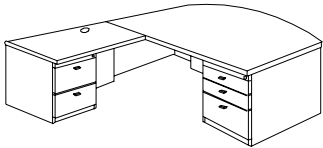

ML 48 RL
Executive 48" Left Return

depth	24	\$618.80
width	48	
height	30	
KD weight *	137	
cubic feet	10.101	
cubic meter	0.286	

Unit Total : \$1,705.60

Right Executive Bow Top "L" Unit

ML 4272 BSL
Left Pedestal Executive Bow Top Desk

depth	42	\$1,086.80
width	72	
height	30	
KD weight *	278	
cubic feet	24.792	
cubic meter	0.702	

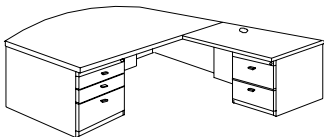

ML 48 RR
Executive 48" Right Return

depth	24	\$618.80
width	48	
height	30	
KD weight *	137	
cubic feet	10.101	
cubic meter	0.286	

Unit Total : \$1,705.60

* This weight does not include Pallet weight

Model	Description	Dimension	List Price
-------	-------------	-----------	------------

Left Executive Bow Top "L" Unit

ML 4272 BSR

Right Pedestal Executive Bow Top Desk

depth	42	\$1,086.80
width	72	
height	30	
KD weight *	278	
cubic feet	24.792	
cubic meter	0.702	

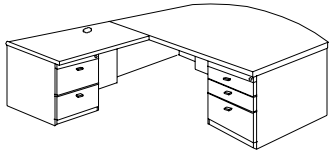

ML 42 RL

Executive 42" Left Return

depth	24	\$598.00
width	42	
height	30	
KD weight *	129	
cubic feet	9.783	
cubic meter	0.277	

Unit Total : \$1,684.80

Right Executive Bow Top "L" Unit

ML 4272 BSL

Left Pedestal Executive Bow Top Desk

depth	42	\$1,086.80
width	72	
height	30	
KD weight *	278	
cubic feet	24.792	
cubic meter	0.702	

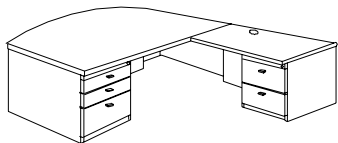

ML 42 RR

Executive 42" Right Return

depth	24	\$598.00
width	42	
height	30	
KD weight *	129	
cubic feet	9.783	
cubic meter	0.277	

Unit Total : \$1,684.80

* This weight does not include Pallet weight

Model	Description	Dimension	List Price
-------	-------------	-----------	------------

Left Executive " L" Unit

ML 3672 ESR
Right Pedestal Executive Desk

depth	36	\$1,055.60
width	72	
height	30	
KD weight *	267	
cubic feet	24.298	
cubic meter	0.688	

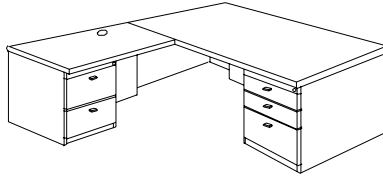

ML 48 RL
Executive 48" Left Return

depth	24	\$618.80
width	48	
height	30	
KD weight *	137	
cubic feet	10.101	
cubic meter	0.286	

Unit Total : \$1,674.40

Right Executive " L" Unit

ML 3672 ESL
Left Pedestal Executive Desk

depth	36	\$1,055.60
width	72	
height	30	
KD weight *	267	
cubic feet	24.298	
cubic meter	0.688	

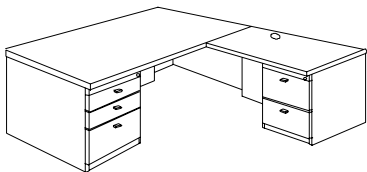

ML 48 RR
Executive 48" Right Return

depth	24	\$618.80
width	48	
height	30	
KD weight *	137	
cubic feet	10.101	
cubic meter	0.286	

\$1,674.40

* This weight does not include Pallet weight

Model	Description	Dimension	List Price
-------	-------------	-----------	------------

Left Executive " L" Unit

ML 3672 ESR
Right Pedestal Executive Desk

depth	36
width	72
height	30
KD weight *	267
cubic feet	24.298
cubic meter	0.688

\$1,055.60

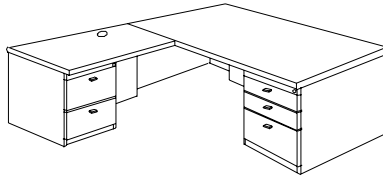

ML 42 RL
Executive 42" Left Return

depth	24
width	42
height	30
KD weight *	129
cubic feet	9.783
cubic meter	0.277

\$598.00

Unit Total : \$1,653.60

Right Executive " L" Unit

ML 3672 ESL
Left Pedestal Executive Desk

depth	36
width	72
height	30
KD weight *	267
cubic feet	24.298
cubic meter	0.688

\$1,055.60

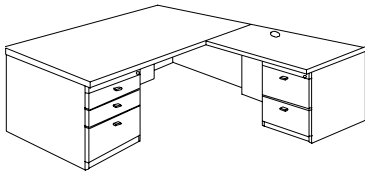

ML 42 RR
Executive 42" Right Return

depth	24
width	42
height	30
KD weight *	129
cubic feet	9.783
cubic meter	0.277

\$598.00

Unit Total : \$1,653.60

* This weight does not include Pallet weight

Model	Description	Dimension	List Price
-------	-------------	-----------	------------

Left Executive " L" Unit

ML 3666 ESR
Right Pedestal Executive Desk

depth	36	\$1,029.60
width	66	
height	30	
KD weight *	260	
cubic feet	23.909	
cubic meter	0.677	

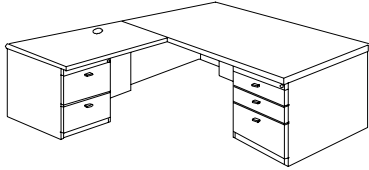

ML 48 RL
Executive 48" Left Return

depth	24	\$618.80
width	48	
height	30	
KD weight *	137	
cubic feet	10.101	
cubic meter	0.286	

Unit Total : \$1,648.40

Right Executive " L" Unit

ML 3666 ESL
Left Pedestal Executive Desk

depth	36	\$1,029.60
width	66	
height	30	
KD weight *	260	
cubic feet	23.909	
cubic meter	0.677	

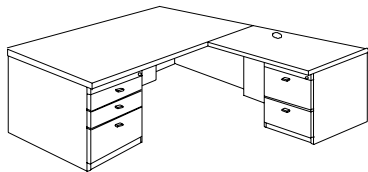

ML 48 RR
Executive 48" Right Return

depth	24	\$618.80
width	48	
height	30	
KD weight *	137	
cubic feet	10.101	
cubic meter	0.286	

Unit Total : \$1,648.40

* This weight does not include Pallet weight

Model	Description	Dimension	List Price
-------	-------------	-----------	------------

Left Executive " L" Unit

ML 3666 ESR
Right Pedestal Executive Desk

depth	36	\$1,029.60
width	66	
height	30	
KD weight *	260	
cubic feet	23.909	
cubic meter	0.677	

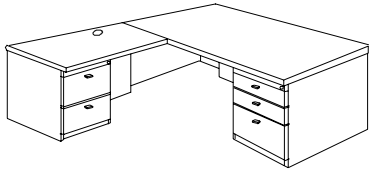

ML 42 RL
Executive 42" Left Return

depth	24	\$598.00
width	42	
height	30	
KD weight *	129	
cubic feet	9.783	
cubic meter	0.277	

Unit Total : \$1,627.60

Right Executive " L" Unit

ML 3666 ESL
Left Pedestal Executive Desk

depth	36	\$1,029.60
width	66	
height	30	
KD weight *	260	
cubic feet	23.909	
cubic meter	0.677	

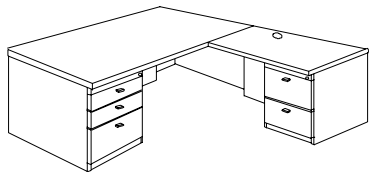

ML 42 RR
Executive 42" Right Return

depth	24	\$598.00
width	42	
height	30	
KD weight *	129	
cubic feet	9.783	
cubic meter	0.277	

Unit Total : \$1,627.60

* This weight does not include Pallet weight

Model	Description	Dimension	List Price
-------	-------------	-----------	------------

Left Executive " L" Unit

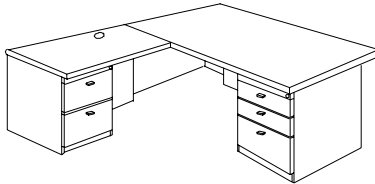

ML 3066 ESR
 Right Pedestal Executive Desk
 24" X 66" Chassis with 30" X 66" Worksurface

depth	30	\$915.20
width	66	
height	30	
KD weight *	211	
cubic feet	16.881	
cubic meter	0.478	

ML 48 RL
 Executive 48" Left Return

depth	24	\$618.80
width	48	
height	30	
KD weight *	137	
cubic feet	10.101	
cubic meter	0.286	

Unit Total : \$1,534.00

Right Executive " L" Unit

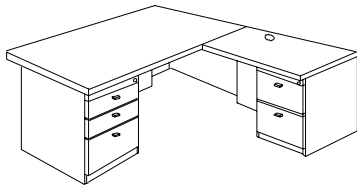

ML 3066 ESL
 Left Pedestal Executive Desk
 24" X 66" Chassis with 30" X 66" Worksurface

depth	30	\$915.20
width	66	
height	30	
KD weight *	211	
cubic feet	16.881	
cubic meter	0.478	

ML 48 RR
 Executive 48" Right Return

depth	24	\$618.80
width	48	
height	30	
KD weight *	137	
cubic feet	10.101	
cubic meter	0.286	

Unit Total : \$1,534.00

* This weight does not include Pallet weight

Model	Description	Dimension	List Price
-------	-------------	-----------	------------

Left Executive " L" Unit

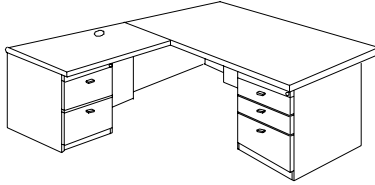

ML 3066 ESR	depth	30	\$915.20
Right Pedestal Executive Desk	width	66	
24" X 66" Chassis with 30" X 66" Worksurface	height	30	
	KD weight *	211	
	cubic feet	16.881	
	cubic meter	0.478	

ML 42 RL	depth	24	\$598.00
Executive 42" Left Return	width	42	
	height	30	
	KD weight *	129	
	cubic feet	9.783	
	cubic meter	0.277	

Unit Total : \$1,513.20

Right Executive " L" Unit

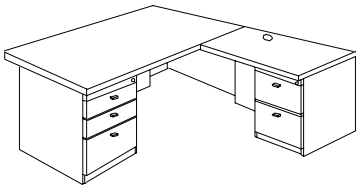

ML 3066 ESL	depth	30	\$915.20
Left Pedestal Executive Desk	width	66	
24" X 66" Chassis with 30" X 66" Worksurface	height	30	
	KD weight *	211	
	cubic feet	16.881	
	cubic meter	0.478	

ML 42 RR	depth	24	\$598.00
Executive 42" Right Return	width	42	
	height	30	
	KD weight *	129	
	cubic feet	9.783	
	cubic meter	0.277	

Unit Total : \$1,513.20

* This weight does not include Pallet weight

Model	Description	Dimension	List Price
-------	-------------	-----------	------------

Left Executive P "L" Unit

ML 4272 PTR
Right Executive P Top Desk

depth 42
width 72
height 30
KD weight * 191
cubic feet 10.418
cubic meter 0.295

\$682.24

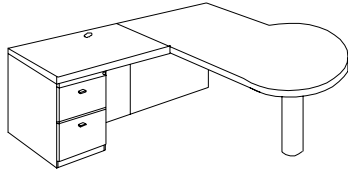

ML 48 RL
Executive 48" Left Return

depth 24
width 48
height 30
KD weight * 137
cubic feet 10.101
cubic meter 0.286

\$618.80

Unit Total : \$1,301.04

Right Executive P "L" Unit

ML 4272 PTL
Left Executive P Top Desk

depth 42
width 72
height 30
KD weight * 191
cubic feet 8.582
cubic meter 0.243

\$682.24

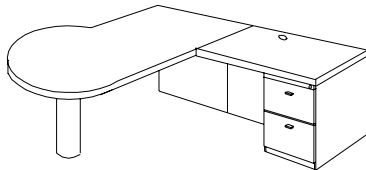

ML 48 RR
Executive 48" Right Return

depth 24
width 48
height 30
KD weight * 137
cubic feet 10.101
cubic meter 0.286

\$618.80

Unit Total : \$1,301.04

* This weight does not include Pallet weight

Model	Description	Dimension	List Price
-------	-------------	-----------	------------

Left Executive P "L" Unit

ML 4272 PTR	depth	42	\$682.24
Right Executive P Top Desk	width	72	
	height	30	
	KD weight *	191	
	cubic feet	8.582	
	cubic meter	0.243	

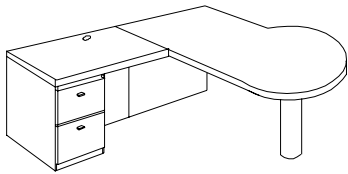

ML 42 RL	depth	24	\$598.00
Executive 42" Left Return	width	42	
	height	30	
	KD weight *	129	
	cubic feet	9.783	
	cubic meter	0.277	

Unit Total : \$1,280.24

Right Executive P "L" Unit

ML 4272 PTL	depth	42	\$682.24
Left Executive P Top Desk	width	72	
	height	30	
	KD weight *	191	
	cubic feet	8.582	
	cubic meter	0.243	

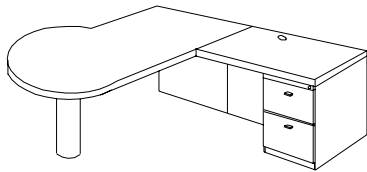

ML 42 RR	depth	24	\$598.00
Executive 42" Right Return	width	42	
	height	30	
	KD weight *	129	
	cubic feet	9.783	
	cubic meter	0.277	

Unit Total : \$1,280.24

* This weight does not include Pallet weight

Model	Description	Dimension	List Price
-------	-------------	-----------	------------

Left Executive Bullet "L" Unit

ML 3672 BTR	depth	36	\$650.00
Right Executive Bullet Top Desk	width	72	
	height	30	
	KD weight *	184	
	cubic feet	8.087	
	cubic meter	0.229	

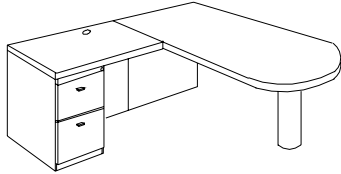

ML 48 RL	depth	24	\$618.80
Executive 48" Left Return	width	48	
	height	30	
	KD weight *	137	
	cubic feet	10.101	
	cubic meter	0.286	

Unit Total : \$1,268.80

Right Executive Bullet "L" Unit

ML 3672 BTL	depth	36	\$650.00
Left Executive Bullet Top Desk	width	72	
	height	30	
	KD weight *	184	
	cubic feet	8.087	
	cubic meter	0.229	

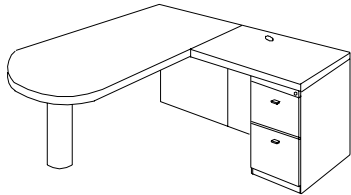

ML 48 RR	depth	24	\$618.80
Executive 48" Right Return	width	48	
	height	30	
	KD weight *	137	
	cubic feet	10.101	
	cubic meter	0.286	

Unit Total : \$1,268.80

* This weight does not include Pallet weight

Model	Description	Dimension	List Price
-------	-------------	-----------	------------

Left Executive Bullet "L" Unit

ML 3672 BTR Right Executive Bullet Top Desk	depth	36	\$650.00
	width	72	
	height	30	
	KD weight *	184	
	cubic feet	9.924	
	cubic meter	0.281	

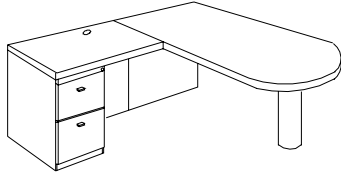

ML 42 RL Executive 42" Left Return	depth	24	\$598.00
	width	42	
	height	30	
	KD weight *	129	
	cubic feet	9.783	
	cubic meter	0.277	

Unit Total : \$1,248.00

Right Executive Bullet "L" Unit

ML 3672 BTL Left Executive Bullet Top Desk	depth	36	\$650.00
	width	72	
	height	30	
	KD weight *	184	
	cubic feet	9.924	
	cubic meter	0.281	

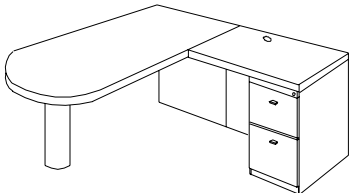

ML 42 RR Executive 42" Right Return	depth	24	\$598.00
	width	42	
	height	30	
	KD weight *	129	
	cubic feet	9.783	
	cubic meter	0.277	

Unit Total : \$1,248.00

* This weight does not include Pallet weight

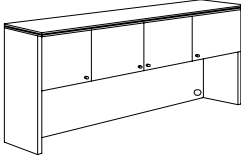
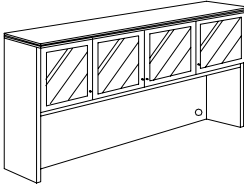
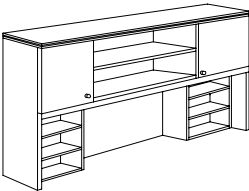
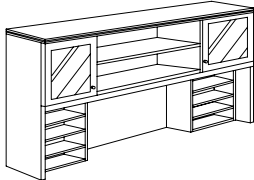
Model	Description	Dimension		List Price
ML 1672 CH	Credenza Hutch	depth	16	\$798.72
	width	72		
	height	42		
	KD Weight *	176		
	cubic feet	6.922		
	cubic meter	0.196		
	ML 1672 CHG	Glass Door Credenza Hutch Clear or Frosted	depth	16
	width	72		
	height	42		
	KD Weight *	177		
	cubic feet	6.922		
	cubic meter	0.196		
	ML 1672 HH	Credenza Home Hutch	depth	16
	width	72		
	height	42		
	KD Weight *	195		
	cubic feet	13.067		
	cubic meter	0.370		
	ML 1672 HHG	Glass door Credenza Home Hutch Clear or Frosted	depth	16
	width	72		
	height	42		
	KD weight *	195		
	cubic feet	11.160		
	cubic meter	0.316		

* This weight does not include Pallet weight

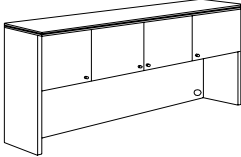
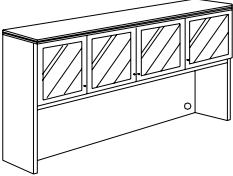
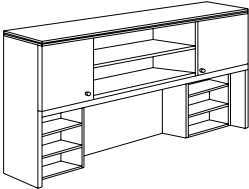
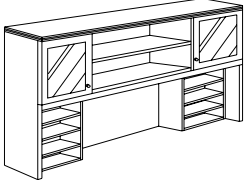
Model	Description	Dimension	List Price
ML 1666 CH	Credenza Hutch	depth 16 width 66 height 42 KD Weight * 168 cubic feet 6.357 cubic meter 0.180	\$772.72
			
ML 1666 CHG	Credenza Hutch Glass Door Credenza Hutch Clear or Frosted	depth 16 width 66 height 42 KD Weight * 167 cubic feet 6.357 cubic meter 0.180	\$829.92
			
ML 1666 HH	Credenza Home Hutch	depth 16 width 66 height 42 KD Weight * 189 cubic feet 11.972 cubic meter 0.339	\$900.64
			
ML 1666 HHG	Glass door Credenza Home Hutch Clear or Frosted	depth 16 width 66 height 42 KD weight * 86 cubic feet 10.670 cubic meter 0.302	\$907.92
			

* This weight does not include Pallet weight

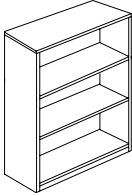
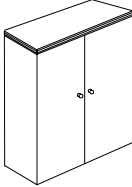
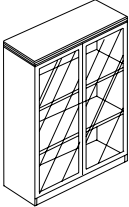
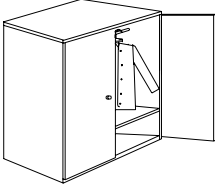
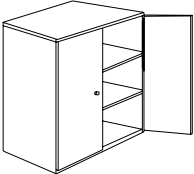
Model	Description	Dimension		List Price
ML 1636 SHO	Open Shelf Storage Hutch	depth	16	\$308.88
		width	36	
		height	42	
		KD weight *	101	
		cubic feet	3.814	
		cubic meter	0.108	
ML 1636 SHD	Storage Hutch	depth	16	\$508.56
		width	36	
		height	42	
		KD weight *	132	
		cubic feet	4.980	
		cubic meter	0.141	
ML 1636 SHG	Storage Hutch with Glass doors Clear or Frosted	depth	16	\$566.80
		width	36	
		height	42	
		KD Weight *	126	
		cubic feet	5.615	
		cubic meter	0.159	
ML 2436 WCH	Wardrobe Cabinet Hutch	depth	24	\$547.04
		width	36	
		height	42	
		KD weight *	157	
		cubic feet	5.933	
		cubic meter	0.168	
ML 2436 SCH	Storage Cabinet Hutch	depth	24	\$579.28
		width	36	
		height	42	
		KD weight *	170	
		cubic feet	6.851	
		cubic meter	0.194	

* This weight does not include Pallet weight

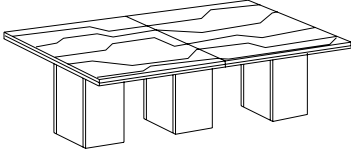
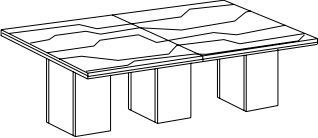
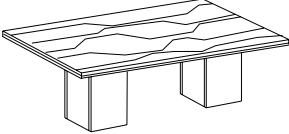
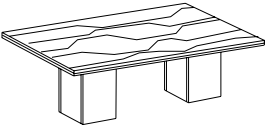
Model	Description	Dimension		List Price
ML 48144 ACT	12-ft Rectangular Conference Table	depth	48	\$1,118.00
		width	144	
		height	30	
		KD weight *	486	
		cubic feet	30.937	
		cubic meter	0.876	
ML 48120 ACT	10-ft Rectangular Conference Table	depth	48	\$1,040.00
		width	120	
		height	30	
		KD Weight *	448	
		cubic feet	29.736	
		cubic meter	0.844	
ML 4896 ACT	8-ft Rectangular Conference Table	depth	48	\$691.60
		width	96	
		height	30	
		KD Weight *	328	
		cubic feet	21.684	
		cubic meter	0.614	
ML 3672 ACT	6-ft Rectangular Conference Table	depth	36	\$556.40
		width	72	
		height	30	
		KD Weight *	174	
		cubic feet	11.902	
		cubic meter	0.337	

* This weight does not include Pallet weight

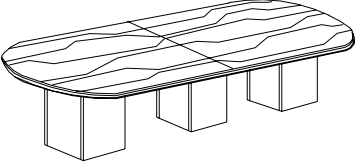
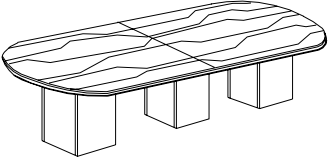
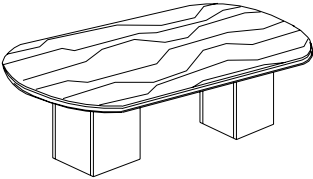
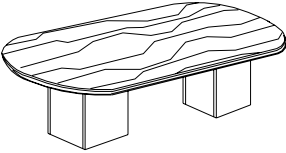
Model	Description	Dimension		List Price
ML 48144 RTCT 	12-ft Racetrack Conference Table	depth	48	\$1,118.00
		width	144	
		height	30	
		KD weight *	471	
		cubic feet	30.937	
		cubic meter	0.876	
		ML 48120 RTCT 	10-ft Racetrack Conference Table	
width	120			
height	30			
KD weight *	433			
cubic feet	29.807			
cubic meter	0.844			
ML 4896 RTCT 	8-ft Racetrack Conference Table			depth
		width	96	
		height	30	
		KD weight *	313	
		cubic feet	21.684	
		cubic meter	0.614	
		ML 3672 RTCT 	6-ft Racetrack Conference Table	depth
width	72			
height	30			
KD weight *	165			
cubic feet	11.902			
cubic meter	0.337			

* This weight does not include Pallet weight

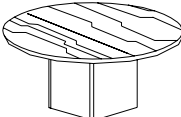
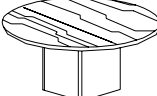
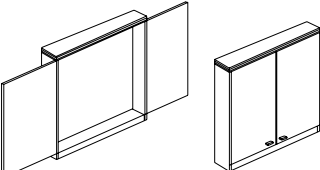
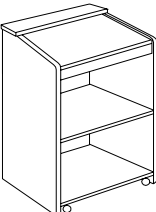
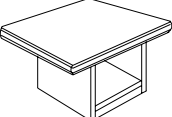
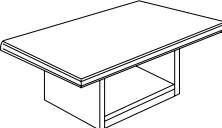
Model	Description	Dimension		List Price
ML 48 RCT 	Round Conference Table	diameter	48	\$379.60
		height	30	
		KD Weight *	147	
		cubic feet	10.772	
		cubic meter	0.305	
ML 42 RCT 	Round Conference Table	diameter	42	\$341.12
		height	30	
		KD Weight *	133	
		cubic feet	10.312	
		cubic meter	0.292	
ML 4848 VB 	Visual Board with white board	depth	5	\$707.20
		width	47	
		height	47	
		KD Weight *	112	
		cubic feet	9.641	
		cubic meter	0.273	
ML 24 LT 	Lectern with fixed shelf and casters	depth	20	\$296.40
		width	24	
		height	47	
		KD Weight *	104	
		cubic feet	3.426	
		cubic meter	0.097	
ML 2424 OT 	Occasional End Table	depth	24	\$142.48
		width	24	
		height	20	
		KD Weight *	42	
		cubic feet	3.779	
		cubic meter	0.107	
ML 2448 OT 	Occasional CoffeeTable	depth	24	\$219.44
		width	48	
		height	18	
		KD Weight *	67	
		cubic feet	8.017	
		cubic meter	0.227	

* This weight does not include Pallet weight

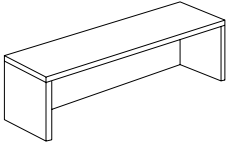
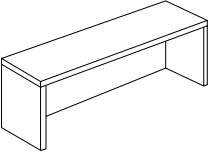
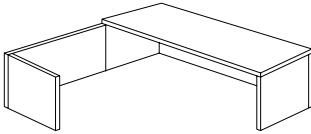
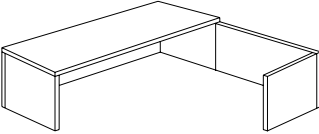
Model	Description	Dimension	List Price	
ML 1472 TC 	Transaction Counter	depth	14	\$213.20
		width	72	
		height	14	
		KD Weight *	66	
		cubic feet	2.755	
		cubic meter	0.078	
		<hr/>		
ML 1466 TC 	Transaction Counter	depth	14	\$199.68
		width	66	
		height	14	
		KD Weight *	57	
		cubic feet	2.543	
		cubic meter	0.072	
		<hr/>		
Left L Unit Transaction Counter				
ML 8472 TCL L 	Front 1472 TC Transaction Counter	depth	14	\$213.20
		width	72	
		height	14	
		KD weight *	66	
		cubic feet	2.755	
		cubic meter	0.078	
		Side 84 CL L Left L Transaction Counter		
width	13			
height	14			
KD weight *	47			
cubic feet	2.578			
cubic meter	0.073			
Unit Total :				\$355.68
<hr/>				
Right L Unit Transaction Counter				
ML 8472 TCL R 	Front 1472 TC Transaction Counter	depth	14	\$213.20
		width	72	
		height	14	
		KD weight *	66	
		cubic feet	2.755	
		cubic meter	0.078	
		Side 84 CL R Right L Transaction Counter		
width	13			
height	14			
KD weight *	47			
cubic feet	2.578			
cubic meter	0.073			
Unit Total :				\$355.68

* This weight does not include Pallet weight

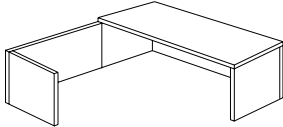
Model	Description	Dimension	List Price	
Left L Unit Transaction Counter				
ML 8466 TCL L	Front 1466 TC	depth 14	\$199.68	
	Transaction Counter	width 66		
		height 14		
		KD weight * 57		
		cubic feet 2.543		
		cubic meter 0.072		
		Side 84 CL L	depth 84	\$142.48
		Left L Transaction Counter	width 13	
		height 14		
		KD weight * 47		
		cubic feet 2.578		
		cubic meter 0.073		
		Unit Total :	\$342.16	

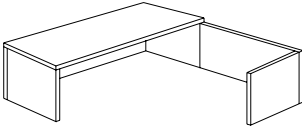
Right L Unit Transaction Counter				
ML 8466 TCL R	Front 1466 TC	depth 14	\$199.68	
	Transaction Counter	width 66		
		height 14		
		KD weight * 57		
		cubic feet 2.543		
		cubic meter 0.072		
		Side 84 CL R	depth 84	\$142.48
		Right L Transaction Counter	width 13	
		height 14		
		KD weight * 47		
		cubic feet 2.578		
		cubic meter 0.073		
		Unit Total :	\$342.16	

* This weight does not include Pallet weight

Model	Description	Dimension	List Price
-------	-------------	-----------	------------

Left L Unit Transaction Counter

ML 7872 TCL L

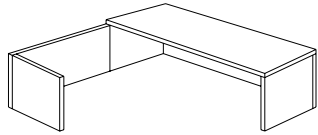

Front 1472 TC
Transaction Counter

depth	14
width	72
height	14
KD weight *	66
cubic feet	2.755
cubic meter	0.078

\$213.20

Side 78 CL L
Left L Transaction Counter

depth	78
width	13
height	14
KD weight *	41
cubic feet	2.225
cubic meter	0.063

\$122.72

Unit Total :

\$335.92

Right L Unit Transaction Counter

ML 7872 TCL R

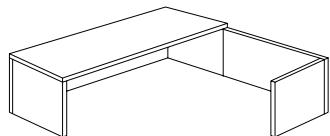

Front 1472 TC
Transaction Counter

depth	14
width	72
height	14
KD weight *	66
cubic feet	2.755
cubic meter	0.078

\$213.20

Side 78 CL R
Right L Transaction Counter

depth	78
width	13
height	14
KD weight *	41
cubic feet	2.225
cubic meter	0.063

\$122.72

Unit Total :

\$335.92

* This weight does not include Pallet weight

Model	Description	Dimension	List Price
-------	-------------	-----------	------------

Left L Unit Transaction Counter
ML 7866 TCL L

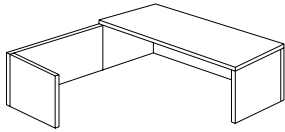

Front 1466 TC
Transaction Counter

depth 14
width 66
height 14
KD weight * 57
cubic feet 2.543
cubic meter 0.072

\$199.68

Side 78 CL L
Left L Transaction Counter

depth 78
width 13
height 14
KD weight * 41
cubic feet 2.225
cubic meter 0.063

\$122.72

Unit Total : \$322.40

Right L Unit Transaction Counter
ML 7866 TCL R

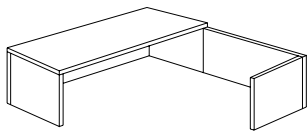

Front 1466 TC
Transaction Counter

depth 14
width 66
height 14
KD weight * 57
cubic feet 2.543
cubic meter 0.072

\$199.68

Side 78 CL R
Right L Transaction Counter

depth 78
width 13
height 14
KD weight * 41
cubic feet 2.225
cubic meter 0.063

\$122.72

Unit Total : \$322.40

* This weight does not include Pallet weight

Model	Description	Dimension	List Price				
Left L Unit Glass Transaction Counter							
	ML 8472 TCG L Left Transaction Glass Counter	depth 84 width 72 height 13 KD weight * 227 cubic feet 7.628 cubic meter 0.216	\$1,040.00				
	Right L Unit Glass Transaction Counter						
		ML 8472 TCG R Right Transaction Glass Counter		depth 84 width 72 height 13 KD weight * 227 cubic feet 7.628 cubic meter 0.216	\$1,040.00		
		Left L Unit Glass Transaction Counter					
				ML 7872 TCG L Left Transaction Glass Counter		depth 78 width 72 height 13 KD weight * 219 cubic feet 7.487 cubic meter 0.212	\$1,024.40
				Right L Unit Glass Transaction Counter			
			ML 7872 TCG R Right Transaction Glass Counter	depth 78 width 72 height 13 KD weight * 219 cubic feet 7.487 cubic meter 0.212		\$1,024.40	

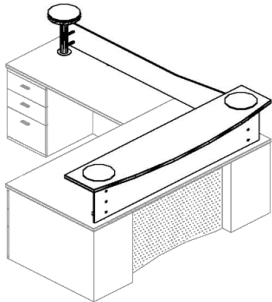
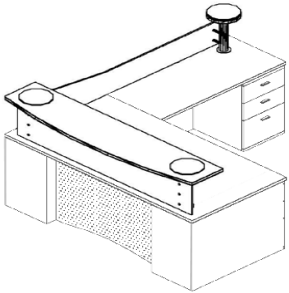
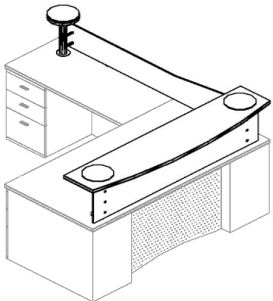
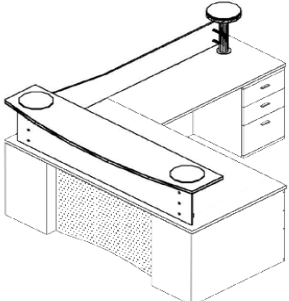

* This weight does not include Pallet weight

Model	Description	Dimension	List Price				
Left L Unit Glass Transaction Counter							
	ML 8466 TCG L Left Transaction Glass Counter	depth 84 width 66 height 13 KD weight * 219 cubic feet 7.165 cubic meter 0.203	\$1,024.40				
	Right L Unit Glass Transaction Counter						
		ML 8466 TCG R Right Transaction Glass Counter		depth 84 width 66 height 13 KD weight * 219 cubic feet 7.165 cubic meter 0.203	\$1,024.40		
		Left L Unit Glass Transaction Counter					
				ML 7866 TCG L Left Transaction Glass Counter		depth 78 width 66 height 13 KD weight * 212 cubic feet 7.028 cubic meter 0.199	\$1,004.64
				Right L Unit Glass Transaction Counter			
			ML 7866 TCG R Right Transaction Glass Counter	depth 78 width 66 height 13 KD weight * 212 cubic feet 7.028 cubic meter 0.199		\$1,004.64	

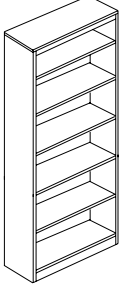
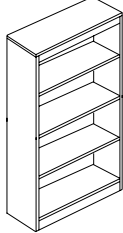
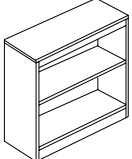
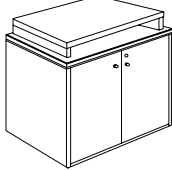
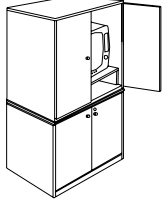
* This weight does not include Pallet weight

Model	Description	Dimension		List Price
ML 3672 BC 	Bookcases	depth	12	\$470.08
		width	36	
		height	72	
		KD Weight *	112	
		cubic feet	5.192	
		cubic meter	0.147	
		ML 3648 BC 	Bookcases	
width	36			
height	48			
KD Weight *	79			
cubic feet	3.532			
cubic meter	0.100			
ML 3630 BC 	Bookcases			depth
		width	36	
		height	30	
		KD Weight *	53	
		cubic feet	2.331	
		cubic meter	0.066	
		ML 2436 LAV 	Low AV Cabinet	depth
width	36			
height	42			
KD weight *	172			
cubic feet	6.781			
cubic meter	0.192			
ML 2436 HAV 	High AV Cabinet			depth
		width	36	
		height	72	
		KD weight *	284	
		cubic feet	11.619	
		cubic meter	0.329	

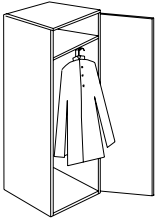
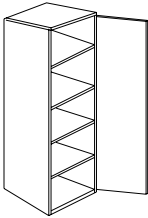
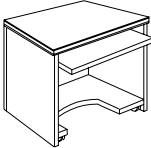
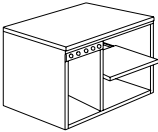
* This weight does not include Pallet weight

Model	Description	Dimension	List Price
ML 2418 HWC 	High Wardrobe Cabinet	depth 24 width 18 height 72 KD weight * 142 cubic feet 1.800 cubic meter 0.510	\$579.28
ML 2418 HSC 	High Storage Cabinet	depth 24 width 18 height 72 KD weight * 162 cubic feet 5.333 cubic meter 0.151	\$618.80
ML 2436 CPS 	Computer / Printer Stand	depth 24 width 36 height 30 KD Weight * 99 cubic feet 4.026 cubic meter 0.114	\$354.64
ML 2436 TP 	Technology Pedestal	depth 24 width 36 height 30 KD weight * 172 cubic feet 6.781 cubic meter 0.192	\$360.88
ML 2415 MBF 	Mobile Pedestal	depth 24 width 16 height 30 KD weight * 88 cubic feet 7.205 cubic meter 0.204	\$431.60



* This weight does not include Pallet weight

Model	Description	Dimension	List Price
TB 72	Tack Board	depth width 70 height 16 KD weight *	\$452.40
TB 66	Tack Board	depth width 64 height 16 KD weight *	\$442.00
SW 72	Slatwall Plastic Toolbar	depth width height KD weight *	\$93.60
SW 66	Slatwall Plastic Toolbar	depth width height KD weight *	\$88.40
SW 30	Slatwall Plastic Toolbar	depth width height KD weight *	\$46.80

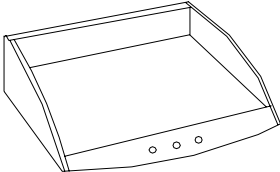
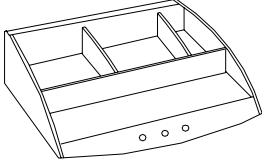
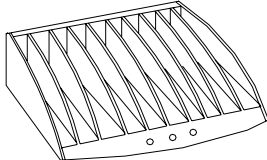
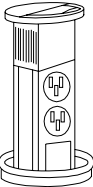
* This weight does not include Pallet weight

Model	Description	Dimension	List Price
SUH1 	Slatwall Utensil Holder	depth width height KD weight *	\$20.80
SPT1 	Slatwall Paper Tray	depth width height KD weight *	\$46.80
SAT 1 	Slatwall Accessory Tray	depth width height KD weight *	\$46.80
SCD 1 	Slatwall CD Holder	depth width height KD weight *	\$36.40
PDCR1 	Retractable Power / Data Center	depth width height KD weight *	\$530.40

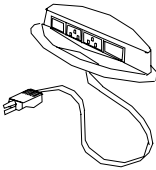
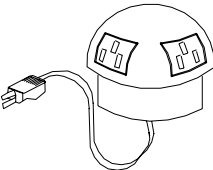
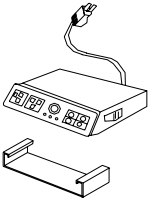
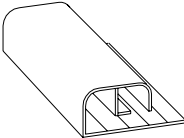
* This weight does not include Pallet weight

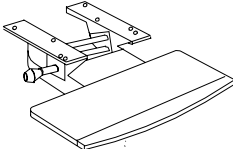
Model	Description	Dimension		List Price
PDCT1 	Work Surface Power / Data Center	depth width height KD weight *		\$530.40
PDCT2 	Work Surface Power / Data Pod	depth width height KD weight *		\$520.00
PDCU1 	Under Top Power / Data Director	depth width height KD weight *		\$166.40
RW1 	Wire Management Race Way	legth width height KD weight *	1-ft 1.18" 2.36"	\$8.32
TG1 	Work Surface Grommet	depth width height KD weight *		\$20.80
26187 VKT 	Keyboard Tray - Medium Density Fiberboard tray - Features 21-3/4" width for ample keyboard space - Soft-touch black vinyl covering	depth width	11 21-3/4	\$364.00

* This weight does not include Pallet weight

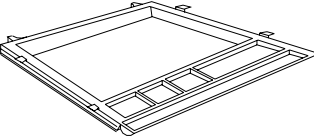
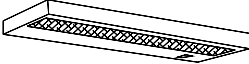
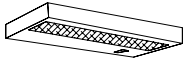
Model	Description	Dimension		List Price
26188 VMP 	Mouse Platform - Steel, Black Powdercoat - For left or right hand operation	depth width	8-3/8 8-3/8	\$109.20
89710 CD 	Central Drawer - Wide pencil drawer - With ball bearing slides - Black color, for use with any desk	depth width	18 23	\$119.60
48 TL 	Task light	depth width height	7 48 2	\$260.00
24 TL 	Task light	depth width height	7 24 2	\$234.00

* This weight does not include Pallet weight