

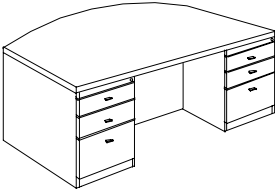

Model	Description	Dimension		List Price
MV 4272 BD 	Double Pedestal Executive - Bow Top Desk	depth	42	\$2,199.60
		width	72	
		height	30	
		KD Weight *	331	
		cubic feet	27.758	
		cubic meter	0.781	
MV 3672 ED 	Double Pedestal Executive Desk	depth	36	\$2,038.40
		width	72	
		height	30	
		KD Weight *	320	
		cubic feet	27.088	
		cubic meter	0.767	
MV 3666 ED 	Double Pedestal Executive Desk	depth	36	\$1,872.00
		width	66	
		height	30	
		KD Weight *	310	
		cubic feet	26.699	
		cubic meter	0.756	
MV 3066 ED 	Double Pedestal Executive Desk 24" X 66" Chassis with 30" X 66" Worksurface	depth	30	\$1,664.00
		width	66	
		height	30	
		KD Weight *	252	
		cubic feet	18.894	
		cubic meter	0.535	

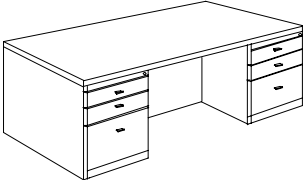
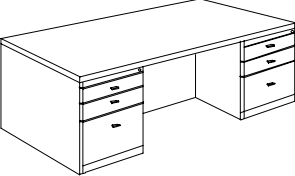
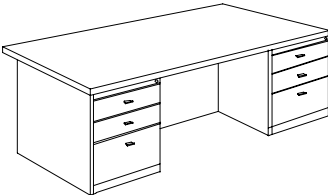
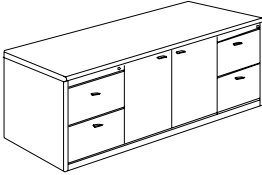
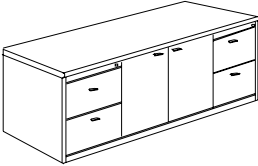
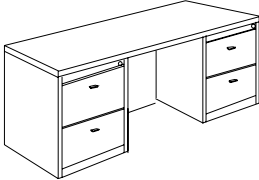
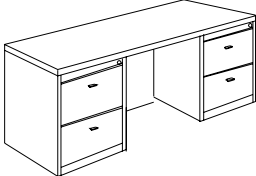
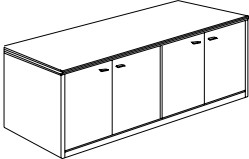
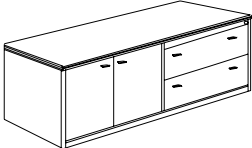

* This weight does not include Pallet weight

Model	Description	Dimension	List Price
MV 2472 SCM 	Storage Credenza	depth 24 width 72 height 30 KD Weight * 352 cubic feet 22.956 cubic meter 0.650	\$2,132.00
MV 2466 SCM 	Storage Credenza	depth 24 width 66 height 30 KD Weight * 323 cubic feet 21.649 cubic meter 0.613	\$2,028.00
MV 2472 KC 	Knee Space Credenza (also available with BBF Pedestals)	depth 24 width 72 height 30 KD Weight * 236 cubic feet 18.824 cubic meter 0.533	\$1,716.00
MV 2466 KC 	Knee Space Credenza (also available with BBF Pedestals)	depth 24 width 66 height 30 KD Weight * 228 cubic feet 18.471 cubic meter 0.523	\$1,664.00
MV 2472 DCC 	Four Door Credenza	depth 24 width 72 height 30 KD Weight * 278 cubic feet 10.560 cubic meter 0.299	\$1,866.80
MV 2472 CFC 	Cabinet Lateral Credenza	depth 24 width 72 height 30 KD Weight * 295 cubic feet 22.461 cubic meter 0.636	\$1,944.80

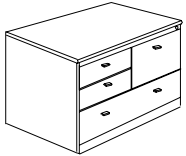
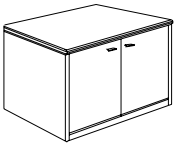
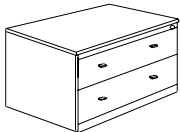
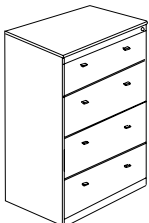
* This weight does not include Pallet weight

Model	Description	Dimension		List Price
MV 2472 DFC	Lateral File Credenza	depth	24	\$2,028.00
		width	72	
		height	30	
		KD Weight *	313	
		cubic feet	34.363	
		cubic meter	0.973	
MV 2436 CP	Combo Pedestal with 24" x 36" Top	depth	24	\$1,560.00
		width	36	
		height	30	
		KD Weight *	196	
		cubic feet	17.234	
		cubic meter	0.488	
MV 2436 DC	Two Door Cabinet with 24" x 36" Top	depth	24	\$936.00
		width	36	
		height	30	
		KD Weight *	141	
		cubic feet	5.333	
		cubic meter	0.151	
MV 2436 LF	Lateral File	depth	24	\$1,014.00
		width	36	
		height	30	
		KD Weight *	159	
		cubic feet	17.234	
		cubic meter	0.488	
MV 2436 FDLF	4 Drawer Lateral File	depth	24	\$1,872.00
		width	36	
		height	55	
		KD Weight *	273	
		cubic feet	31.114	
		cubic meter	0.881	

* This weight does not include Pallet weight

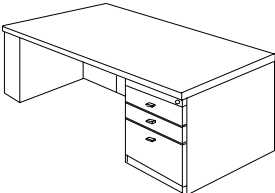
Model	Description	Dimension		List Price
MV 4272 BSL	Left Pedestal Executive Bow Top Desk	depth	42	\$1,716.00
		width	72	
		height	30	
		KD Weight *	278	
		cubic feet	24.792	
		cubic meter	0.702	
				
MV 4272 BSR	Right Pedestal Executive Bow Top Desk	depth	42	\$1,716.00
		width	72	
		height	30	
		KD Weight *	278	
		cubic feet	24.792	
		cubic meter	0.702	
				
MV 3672 ESL	Left Pedestal Executive Desk	depth	36	\$1,632.80
		width	72	
		height	30	
		KD Weight *	267	
		cubic feet	24.298	
		cubic meter	0.688	
				
MV 3672 ESR	Right Pedestal Executive Desk	depth	36	\$1,632.80
		width	72	
		height	30	
		KD Weight *	267	
		cubic feet	24.298	
		cubic meter	0.688	
				

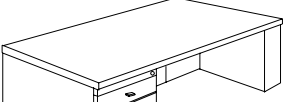

* This weight does not include Pallet weight

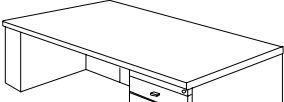
Model	Description	Dimension		List Price
MV 3666 ESL	Left Pedestal Executive Desk	depth	36	\$1,560.00
		width	66	
		height	30	
		KD Weight *	257	
		cubic feet	23.909	
		cubic meter	0.677	

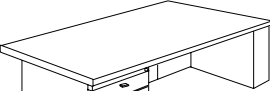
MV 3666 ESR	Right Pedestal Executive Desk	depth	36	\$1,560.00
		width	66	
		height	30	
		KD Weight *	257	
		cubic feet	23.909	
		cubic meter	0.677	

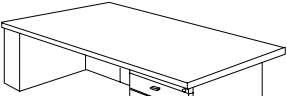
MV 3066 ESL	Left Pedestal Executive Desk	depth	30	\$1,336.40
	24" X 66" Chassis with 30" X 66" Worksurface	width	66	
		height	30	
		KD Weight *	211	
		cubic feet	16.881	
		cubic meter	0.478	

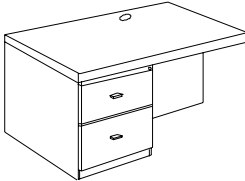
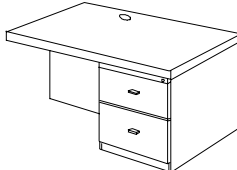
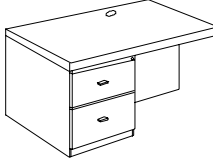
MV 3066 ESR	Right Pedestal Executive Desk	depth	30	\$1,336.40
	24" X 66" Chassis with 30" X 66" Worksurface	width	66	
		height	30	
		KD Weight *	211	
		cubic feet	16.881	
		cubic meter	0.478	

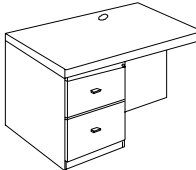
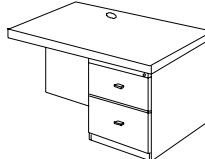
Model	Description	Dimension	List Price
MV 48 RL 	Executive 48" Left Return	depth 24	\$910.00
		width 48	
height 30			
KD Weight * 137			
cubic feet 10.101			
cubic meter 0.286			
MV 48 RR 	Executive 48" Right Return	depth 24	\$910.00
		width 48	
height 30			
KD Weight * 137			
cubic feet 10.101			
cubic meter 0.286			
MV 42 RL 	Executive 42" Left Return	depth 24	\$806.00
		width 42	
height 30			
KD Weight * 129			
cubic feet 9.783			
cubic meter 0.277			
MV 42 RR 	Executive 42" Right Return	depth 24	\$806.00
		width 42	
height 30			
KD Weight * 129			
cubic feet 9.783			
cubic meter 0.277			
MV 36 RL 	Executive 36" Left Return	depth 24	\$754.00
		width 36	
height 30			
KD Weight * 120			
cubic feet 9.465			
cubic meter 0.268			
MV 36 RR 	Executive 36" Right Return	depth 24	\$754.00
		width 36	
height 30			
KD Weight * 120			
cubic feet 9.465			
cubic meter 0.268			

* This weight does not include Pallet weight

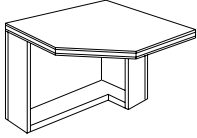
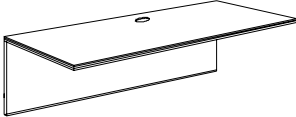
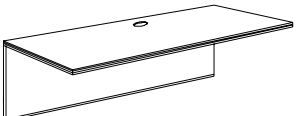
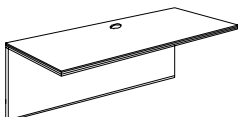
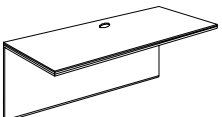
Model	Description	Dimension		List Price
MV 3636 CU	Corner Unit	depth	36	\$696.80
		width	36	
		height	30	
		KD Weight *	93	
		cubic feet	10.206	
		cubic meter	0.289	
MV 48 EB	Executive 48" Bridge	depth	24	\$374.40
		width	48	
		height	30	
		KD Weight *	69	
		cubic feet	2.825	
		cubic meter	0.080	
MV 42 EB	Executive 42" Bridge	depth	24	\$338.00
		width	42	
		height	30	
		KD Weight *	62	
		cubic feet	2.507	
		cubic meter	0.071	
MV 36 EB	Executive 36" Bridge	depth	24	\$291.20
		width	36	
		height	30	
		KD Weight *	53	
		cubic feet	1.190	
		cubic meter	0.062	
MV 30 EB	Executive 30" Bridge	depth	24	\$244.40
		width	30	
		height	30	
		KD Weight *	44	
		cubic feet	1.872	
		cubic meter	0.053	

* This weight does not include Pallet weight

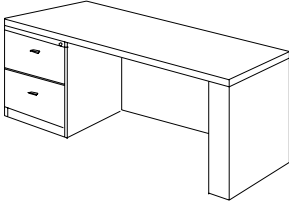
Model	Description	Dimension	List Price	
MV 2472 CL 	Left Pedestal Credenza	depth	24	\$1,341.60
		width	72	
		height	30	
		KD Weight *	209	
		cubic feet	19.707	
		cubic meter	0.558	

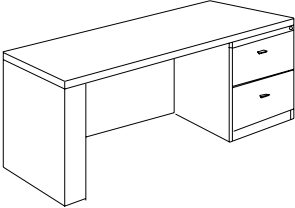
MV 2472 CR 	Right Pedestal Credenza	depth	24	\$1,341.60
		width	72	
		height	30	
		KD Weight *	209	
		cubic feet	19.707	
		cubic meter	0.558	

MV 2466 CL 	Left Pedestal Credenza	depth	24	\$1,289.60
		width	66	
		height	30	
		KD Weight *	201	
		cubic feet	19.353	
		cubic meter	0.548	

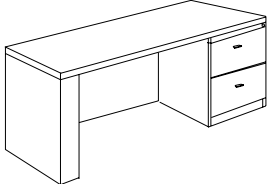
MV 2466 CR 	Right Pedestal Credenza	depth	24	\$1,289.60
		width	66	
		height	30	
		KD Weight *	201	
		cubic feet	19.353	
		cubic meter	0.548	

* This weight does not include Pallet weight

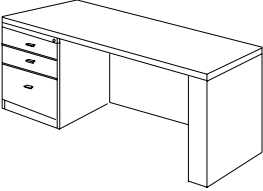
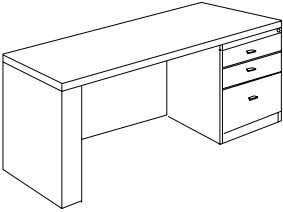
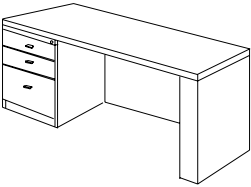
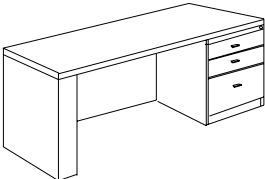
Model	Description	Dimension		List Price
MV 2472 CBL	Left Pedestal Credenza with 24" Deep BBF	depth	24	\$1,393.60
	width	72		
	height	30		
	KD Weight *	236		
	cubic feet	23.380		
	cubic meter	0.662		
	MV 2472 CBR	Right Pedestal Credenza with 24" Deep BBF	depth	24
	width	72		
	height	30		
	KD Weight *	236		
	cubic feet	23.380		
	cubic meter	0.662		
	MV 2466 CBL	Left Pedestal Credenza with 24" Deep BBF	depth	24
	width	66		
	height	30		
	KD Weight *	228		
	cubic feet	23.026		
	cubic meter	0.652		
	MV 2466 CBR	Right Pedestal Credenza with 24" Deep BBF	depth	24
	width	66		
	height	30		
	KD Weight *	228		
	cubic feet	23.026		
	cubic meter	0.652		

* This weight does not include Pallet weight

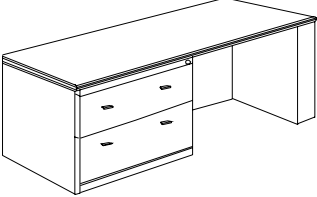
Model	Description	Dimension		List Price
MV 2472 SFCL 	Left Single Lateral File Credenza	depth	24	\$1,716.00
		width	72	
		height	30	
		KD Weight *	248	
		cubic feet	27.476	
		cubic meter	0.778	

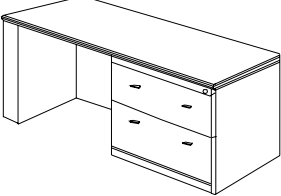
MV 2472 SFCR 	Right Single Lateral File Credenza	depth	24	\$1,716.00
		width	72	
		height	30	
		KD Weight *	248	
		cubic feet	27.476	
		cubic meter	0.778	

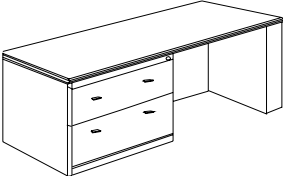
MV 2466 SFCL 	Left Single Lateral File Credenza	depth	24	\$1,664.00
		width	66	
		height	30	
		KD Weight *	240	
		cubic feet	27.123	
		cubic meter	0.768	

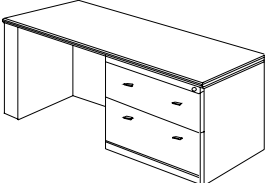
MV 2466 SFCR 	Right Single Lateral File Credenza	depth	24	\$1,664.00
		width	66	
		height	30	
		KD Weight *	240	
		cubic feet	27.123	
		cubic meter	0.768	

* This weight does not include Pallet weight

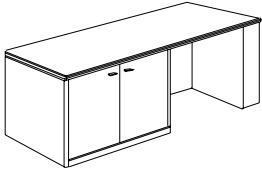
Model	Description	Dimension		List Price
MV 2472 SCCL	Left Single Cabinet Credenza	depth	24	\$1,612.00
		width	72	
		height	30	
		KD Weight *	230	
		cubic feet	15.575	
		cubic meter	0.441	

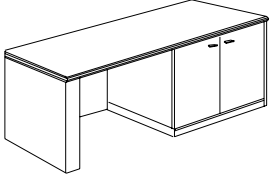
MV 2472 SCCR	Right Single Cabinet Credenza	depth	24	\$1,612.00
		width	72	
		height	30	
		KD Weight *	230	
		cubic feet	15.575	
		cubic meter	0.441	

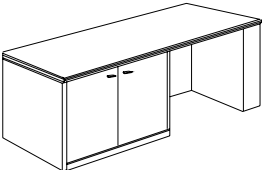
MV 2466 SCCL	Left Single Cabinet Credenza	depth	24	\$1,554.80
		width	66	
		height	30	
		KD Weight *	223	
		cubic feet	15.221	
		cubic meter	0.431	

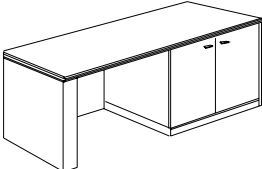
MV 2466 SCCR	Right Single Cabinet Credenza	depth	24	\$1,554.80
		width	66	
		height	30	
		KD Weight *	223	
		cubic feet	15.221	
		cubic meter	0.431	

Model	Description	Dimension		List Price
MV 2472 CPCL	Left Combo Pedestal Credenza	depth	24	\$2,392.00
	width	72		
	height	30		
	KD Weight *	286		
	cubic feet	27.476		
	cubic meter	0.778		
	MV 2472 CPR	Right Combo Pedestal Credenza	depth	24
	width	72		
	height	30		
	KD Weight *	286		
	cubic feet	27.476		
	cubic meter	0.778		
	MV 2466 CPCL	Left Combo Pedestal Credenza	depth	24
	width	66		
	height	30		
	KD Weight *	278		
	cubic feet	27.123		
	cubic meter	0.768		
	MV 2466 CPR	Right Combo Pedestal Credenza	depth	24
	width	66		
	height	30		
	KD Weight *	278		
	cubic feet	27.123		
	cubic meter	0.768		

* This weight does not include Pallet weight

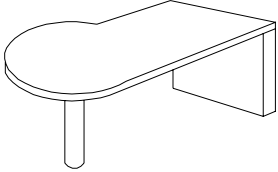
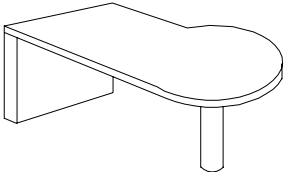
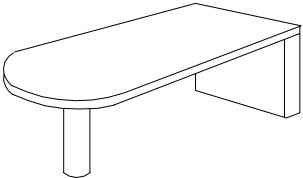
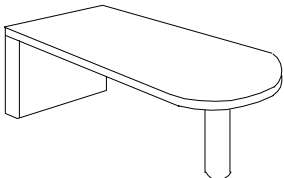
Model	Description	Dimension	List Price
MV 4272 PTL 	Left Executive P-Top Desk	depth	42
		width	72
		height	30
		KD Weight *	191
		cubic feet	10.418
		cubic meter	0.295
		\$1,071.20	
MV 4272 PTR 	Right Executive P-Top Desk	depth	42
		width	72
		height	30
		KD Weight *	191
		cubic feet	10.418
		cubic meter	0.295
		\$1,071.20	
MV 3672 BTL 	Left Executive Bullet Top Desk	depth	36
		width	72
		height	30
		KD Weight *	184
		cubic feet	9.924
		cubic meter	0.281
		\$1,019.20	
MV 3672 BTR 	Right Executive Bullet Top Desk	depth	36
		width	72
		height	30
		KD Weight *	184
		cubic feet	9.924
		cubic meter	0.281
		\$1,019.20	

* This weight does not include Pallet weight

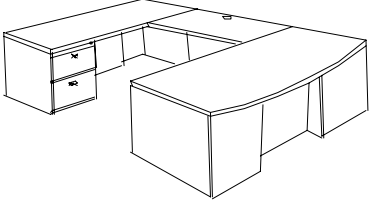
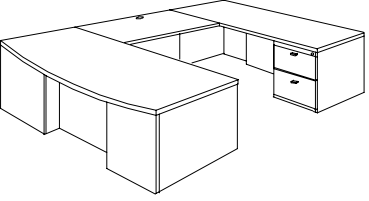
Model	Description	Dimension	List Price	
Left Executive Bow Top "U" Unit				
	MV 4272 BSR Right Pedestal Executive Bow Top Desk	depth 42 width 72 height 30 KD weight * 278 cubic feet 24.792 cubic meter 0.702	\$1,716.00	
	MV 48 EB Executive 48" Bridge	depth 24 width 48 height 30 KD weight * 69 cubic feet 2.825 cubic meter 0.080	\$374.40	
	MV 2472 CL Left Pedestal Credenza (For Optional Credenzas, please see page 14 to 18)	depth 24 width 72 height 30 KD weight * 209 cubic feet 19.707 cubic meter 0.558	\$1,341.60	
	Unit Total :		\$3,432.00	
	Right Executive Bow Top "U" Unit			
		MV 4272 BSL Left Pedestal Executive Bow Top Desk	depth 42 width 72 height 30 KD weight * 278 cubic feet 24.792 cubic meter 0.702	\$1,716.00
		MV 48 EB Executive 48" Bridge	depth 24 width 48 height 30 KD weight * 69 cubic feet 2.825 cubic meter 0.080	\$374.40
		MV 2472 CR Right Pedestal Credenza (For Optional Credenzas, please see page 14 to 18)	depth 24 width 72 height 30 KD weight * 209 cubic feet 19.707 cubic meter 0.558	\$1,341.60
		Unit Total :		\$3,432.00

* This weight does not include Pallet weight

Model	Description	Dimension	List Price
-------	-------------	-----------	------------

Left Executive Bow Top "U" Unit

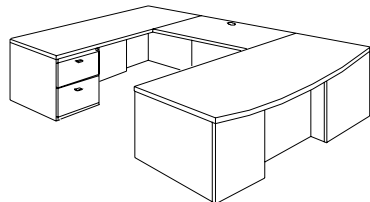

MV 4272 BSR Right Pedestal Executive Bow Top Desk	depth	42	\$1,716.00
	width	72	
	height	30	
	KD weight *	278	
	cubic feet	24.792	
	cubic meter	0.702	

MV 42 EB Executive 42" Bridge	depth	24	\$338.00
	width	42	
	height	30	
	KD weight *	62	
	cubic feet	2.507	
	cubic meter	0.071	

MV 2472 CL Left Pedestal Credenza (For Optional Credenzas, please see page 14 to 18)	depth	24	\$1,341.60
	width	72	
	height	30	
	KD weight *	209	
	cubic feet	19.707	
	cubic meter	0.558	

Unit Total : \$3,395.60

Right Executive Bow Top "U" Unit

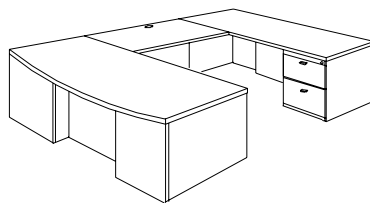

MV 4272 BSL Left Pedestal Executive Bow Top Desk	depth	42	\$1,716.00
	width	72	
	height	30	
	KD weight *	278	
	cubic feet	24.792	
	cubic meter	0.702	

MV 42 EB Executive 42" Bridge	depth	24	\$338.00
	width	42	
	height	30	
	KD weight *	62	
	cubic feet	2.507	
	cubic meter	0.071	

MV 2472 CR Right Pedestal Credenza (For Optional Credenzas, please see page 14 to 18)	depth	24	\$1,341.60
	width	72	
	height	30	
	KD weight *	209	
	cubic feet	19.707	
	cubic meter	0.558	

\$3,395.60

* This weight does not include Pallet weight

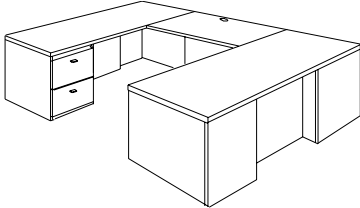
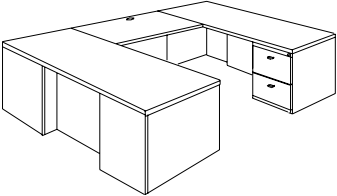
Model	Description	Dimension	List Price	
Left Executive "U" Unit				
	MV 3672 ESR Right Pedestal Executive Desk	depth 36 width 72 height 30 KD weight * 267 cubic feet 27.088 cubic meter 0.767	\$1,632.80	
	MV 48 EB Executive 48" Bridge	depth 24 width 48 height 30 KD weight * 69 cubic feet 2.437 cubic meter 0.069	\$374.40	
	MV 2472 CL Left Pedestal Credenza (For Optional Credenzas, please see page 14 to 18)	depth 24 width 72 height 30 KD weight * 209 cubic feet 19.707 cubic meter 0.558	\$1,341.60	
	Unit Total :		\$3,348.80	
	Right Executive "U" Unit			
		MV 3672 ESL Left Pedestal Executive Desk	depth 36 width 72 height 30 KD weight * 267 cubic feet 27.088 cubic meter 0.767	\$1,632.80
		MV 48 EB Executive 48" Bridge	depth 24 width 48 height 30 KD weight * 69 cubic feet 2.437 cubic meter 0.069	\$374.40
		MV 2472 CR Right Pedestal Credenza (For Optional Credenzas, please see page 14 to 18)	depth 24 width 72 height 30 KD weight * 209 cubic feet 19.707 cubic meter 0.558	\$1,341.60
		Unit Total :		\$3,348.80

* This weight does not include Pallet weight

Model	Description	Dimension	List Price
-------	-------------	-----------	------------

Left Executive "U" Unit

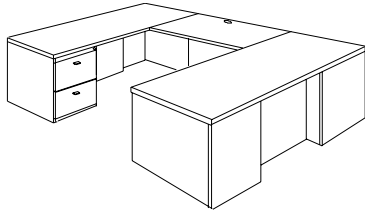

MV 3672 ESR
Right Pedestal Executive Desk

depth 36
width 72
height 30
KD weight * 267
cubic feet 27.088
cubic meter 0.767

\$1,632.80

MV 42 EB
Executive 42" Bridge

depth 24
width 42
height 30
KD weight * 62
cubic feet 2.507
cubic meter 0.071

\$338.00

MV 2472 CL
Left Pedestal Credenza
(For Optional Credenzas, please see page 14 to 18)

depth 24
width 72
height 30
KD weight * 209
cubic feet 19.707
cubic meter 0.558

\$1,341.60

Unit Total : \$3,312.40

Right Executive "U" Unit

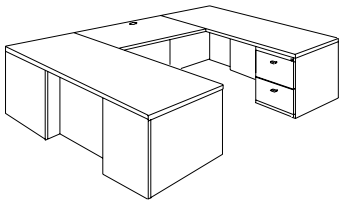

MV 3672 ESL
Left Pedestal Executive Desk

depth 36
width 72
height 30
KD weight * 267
cubic feet 27.088
cubic meter 0.767

\$1,632.80

MV 42 EB
Executive 42" Bridge

depth 24
width 42
height 30
KD weight * 62
cubic feet 2.507
cubic meter 0.071

\$338.00

MV 2472 CR
Right Pedestal Credenza
(For Optional Credenzas, please see page 14 to 18)

depth 24
width 72
height 30
KD weight * 209
cubic feet 19.707
cubic meter 0.558

\$1,341.60

Unit Total : \$3,312.40

* This weight does not include Pallet weight

Model	Description	Dimension	List Price
-------	-------------	-----------	------------

Left Executive "U" Unit

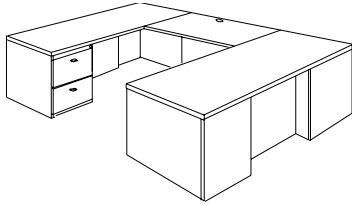

MV 3666 ESR
Right Pedestal Executive Desk

depth	36	\$1,560.00
width	66	
height	30	
KD weight *	257	
cubic feet	26.699	
cubic meter	0.756	

MV 48 EB
Executive 48" Bridge

depth	24	\$374.40
width	48	
height	30	
KD weight *	69	
cubic feet	2.437	
cubic meter	0.069	

MV 2466 CL
Left Pedestal Credenza
(For Optional Credenzas, please see page 14 to 18)

depth	24	\$1,289.60
width	66	
height	30	
KD weight *	201	
cubic feet	19.707	
cubic meter	0.558	

Unit Total : \$3,224.00

Right Executive "U" Unit

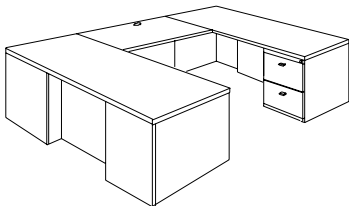

MV 3666 ESL
Left Pedestal Executive Desk

depth	36	\$1,560.00
width	66	
height	30	
KD weight *	257	
cubic feet	26.699	
cubic meter	0.756	

MV 48 EB
Executive 48" Bridge

depth	24	\$374.40
width	48	
height	30	
KD weight *	69	
cubic feet	2.437	
cubic meter	0.069	

MV 2466 CR
Right Pedestal Credenza
(For Optional Credenzas, please see page 14 to 18)

depth	24	\$1,289.60
width	66	
height	30	
KD weight *	201	
cubic feet	16.281	
cubic meter	0.461	

Unit Total : \$3,224.00

* This weight does not include Pallet weight

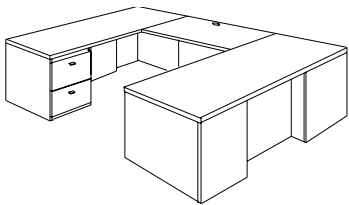
Model	Description	Dimension	List Price
Left Executive "U" Unit			
	MV 3666 ESR Right Pedestal Executive Desk	depth 36 width 66 height 30 KD weight * 257 cubic feet 26.699 cubic meter 0.756	\$1,560.00
	MV 42 EB Executive 42" Bridge	depth 24 width 42 height 30 KD weight * 62 cubic feet 2.507 cubic meter 0.071	\$338.00
	MV 2466 CL Left Pedestal Credenza (For Optional Credenzas, please see page 14 to 18)	depth 24 width 66 height 30 KD weight * 201 cubic feet 16.281 cubic meter 0.461	\$1,289.60
	Unit Total :		\$3,187.60

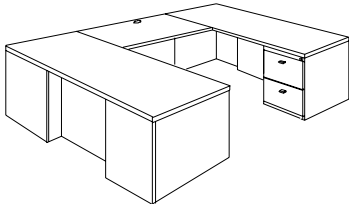
Right Executive "U" Unit			
	MV 3666 ESL Left Pedestal Executive Desk	depth 36 width 66 height 30 KD weight * 257 cubic feet 26.699 cubic meter 0.756	\$1,560.00
	MV 42 EB Executive 42" Bridge	depth 24 width 42 height 30 KD weight * 62 cubic feet 2.507 cubic meter 0.071	\$338.00
	MV 2466 CR Right Pedestal Credenza (For Optional Credenzas, please see page 14 to 18)	depth 24 width 66 height 30 KD weight * 201 cubic feet 16.281 cubic meter 0.461	\$1,289.60
	Unit Total :		\$3,187.60

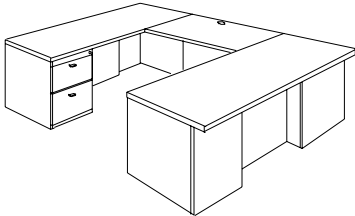
Model	Description	Dimension	List Price
Left Executive "U" Unit			
	MV 3066 ESR	depth 30	\$1,336.40
	Right Pedestal Executive Desk	width 66	
	24" X 66" Chassis with 30" X 66" Worksurface	height 30	
		KD weight * 211	
		cubic feet 18.894	
		cubic meter 0.535	
	MV 48 EB	depth 24	\$374.40
	Executive 48" Bridge	width 48	
		height 30	
		KD weight * 69	
	cubic feet 2.437		
	cubic meter 0.069		
MV 2466 CL	depth 24	\$1,289.60	
Left Pedestal Credenza	width 66		
(For Optional Credenzas, please see page 14 to 18)	height 30		
	KD weight * 201		
	cubic feet 16.281		
	cubic meter 0.461		
	Unit Total :		\$3,000.40

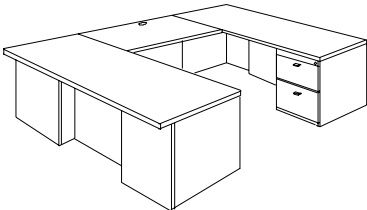
Right Executive "U" Unit			
	MV 3066 ESL	depth 30	\$1,336.40
	Left Pedestal Executive Desk	width 66	
	24" X 66" Chassis with 30" X 66" Worksurface	height 30	
		KD weight * 211	
		cubic feet 18.894	
		cubic meter 0.535	
	MV 48 EB	depth 24	\$374.40
	Executive 48" Bridge	width 48	
		height 30	
		KD weight * 69	
	cubic feet 2.437		
	cubic meter 0.069		
MV 2466 CR	depth 24	\$1,289.60	
Right Pedestal Credenza	width 66		
(For Optional Credenzas, please see page 14 to 18)	height 30		
	KD weight * 201		
	cubic feet 16.281		
	cubic meter 0.461		
	Unit Total :		\$3,000.40

Model	Description	Dimension	List Price
-------	-------------	-----------	------------

Left Executive "U" Unit

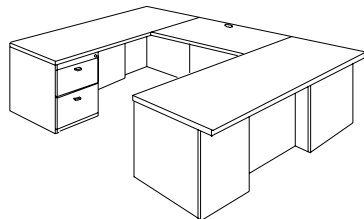

MV 3066 ESR
 Right Pedestal Executive Desk
 24" X 66" Chassis with 30" X 66" Worksurface

depth 30
 width 66
 height 30
 KD weight * 211
 cubic feet 18.894
 cubic meter 0.535

\$1,336.40

MV 42 EB
 Executive 42" Bridge

depth 24
 width 42
 height 30
 KD weight * 62
 cubic feet 2.507
 cubic meter 0.071

\$338.00

MV 2466 CL
 Left Pedestal Credenza
 (For Optional Credenzas, please see page 14 to 18)

depth 24
 width 66
 height 30
 KD weight * 201
 cubic feet 16.281
 cubic meter 0.461

\$1,289.60

Unit Total : \$2,964.00

Right Executive "U" Unit

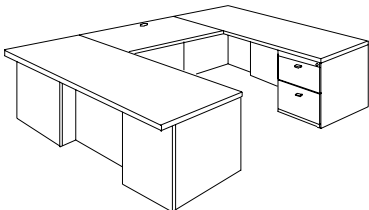

MV 3066 ESL
 Left Pedestal Executive Desk
 24" X 66" Chassis with 30" X 66" Worksurface

depth 30
 width 66
 height 30
 KD weight * 211
 cubic feet 18.894
 cubic meter 0.535

\$1,336.40

MV 42 EB
 Executive 42" Bridge

depth 24
 width 42
 height 30
 KD weight * 62
 cubic feet 2.507
 cubic meter 0.071

\$338.00

MV 2466 CR
 Right Pedestal Credenza
 (For Optional Credenzas, please see page 14 to 18)

depth 24
 width 66
 height 30
 KD weight * 201
 cubic feet 16.281
 cubic meter 0.461

\$1,289.60

Unit Total : \$2,964.00

* This weight does not include Pallet weight

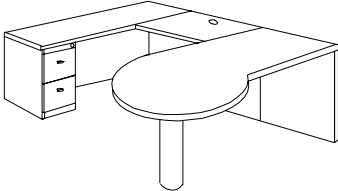
Model	Description	Dimension	List Price
Left Executive P "U" Unit			
	MV 4272 PTR Right Executive P Top Desk	depth 42 width 72 height 30 KD weight * 191 cubic feet 10.418 cubic meter 0.295	\$1,071.20
	MV 48 EB Executive 48" Bridge	depth 24 width 48 height 30 KD weight * 69 cubic feet 2.437 cubic meter 0.069	\$374.40
	MV 2472 CL Left Pedestal Credenza (For Optional Credenzas, please see page 14 to 18)	depth 24 width 72 height 30 KD weight * 209 cubic feet 19.707 cubic meter 0.558	\$1,341.60
	Unit Total :		\$2,787.20

Right Executive P "U" Unit

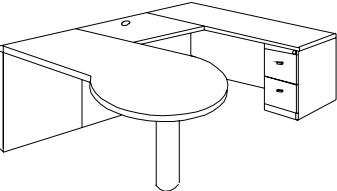
	MV 4272 PTL Left Executive P Top Desk	depth 42 width 72 height 30 KD weight * 191 cubic feet 10.418 cubic meter 0.295	\$1,071.20
	MV 48 EB Executive 48" Bridge	depth 24 width 48 height 30 KD weight * 69 cubic feet 2.437 cubic meter 0.069	\$374.40
	MV 2472 CR Right Pedestal Credenza (For Optional Credenzas, please see page 14 to 18)	depth 24 width 72 height 30 KD weight * 209 cubic feet 19.707 cubic meter 0.558	\$1,341.60
	Unit Total :		\$2,787.20

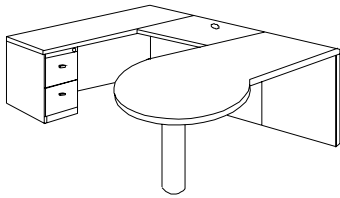
Model	Description	Dimension	List Price	
Left Executive P "U" Unit				
	MV 4272 PTR	depth 42	\$1,071.20	
	Right Executive P Top Desk	width 72		
		height 30		
		KD weight * 191		
		cubic feet 10.418		
		cubic meter 0.295		
		MV 42 EB	depth 24	\$338.00
	Executive 42" Bridge	width 42		
		height 30		
		KD weight * 62		
	cubic feet 2.507			
	MV 2472 CL	depth 24	\$1,341.60	
Left Pedestal Credenza	width 72			
(For Optional Credenzas, please see page 14 to 18)	height 30			
	KD weight * 209			
	cubic feet 19.707			
	cubic meter 0.558			
	Unit Total :		\$2,750.80	

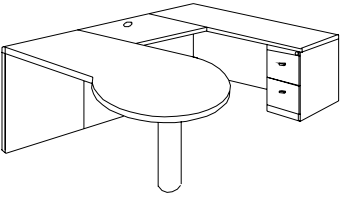
Right Executive P "U" Unit				
	MV 4272 PTL	depth 42	\$1,071.20	
	Left Executive P Top Desk	width 72		
		height 30		
		KD weight * 191		
		cubic feet 8.582		
		cubic meter 0.243		
		MV 42 EB	depth 24	\$338.00
	Executive 42" Bridge	width 42		
		height 30		
		KD weight * 62		
	cubic feet 10.418			
	MV 2472 CR	depth 24	\$1,341.60	
Right Pedestal Credenza	width 72			
(For Optional Credenzas, please see page 14 to 18)	height 30			
	KD weight * 209			
	cubic feet 19.707			
	cubic meter 0.558			
	Unit Total :		\$2,750.80	

Model	Description	Dimension	List Price
-------	-------------	-----------	------------

Left Executive Bullet "U" Unit

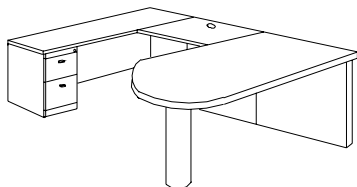

MV 3672 BTR
Right Executive Bullet Top Desk

depth	36	\$1,019.20
width	72	
height	30	
KD weight *	184	
cubic feet	9.924	
cubic meter	0.281	

MV 48 EB
Executive 48" Bridge

depth	24	\$374.40
width	48	
height	30	
KD weight *	69	
cubic feet	2.437	
cubic meter	0.069	

MV 2472 CL
Left Pedestal Credenza
(For Optional Credenzas, please see page 14 to 18)

depth	24	\$1,341.60
width	72	
height	30	
KD weight *	209	
cubic feet	19.707	
cubic meter	0.558	

Unit Total : \$2,735.20

Right Executive Bullet "U" Unit

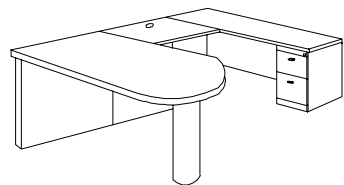

MV 3672 BTL
Left Executive Bullet Top Desk

depth	36	\$1,019.20
width	72	
height	30	
KD weight *	184	
cubic feet	9.924	
cubic meter	0.281	

MV 48 EB
Executive 48" Bridge

depth	24	\$374.40
width	48	
height	30	
KD weight *	69	
cubic feet	2.437	
cubic meter	0.069	

MV 2472 CR
Right Pedestal Credenza
(For Optional Credenzas, please see page 14 to 18)

depth	24	\$1,341.60
width	72	
height	30	
KD weight *	209	
cubic feet	19.707	
cubic meter	0.558	

Unit Total : \$2,735.20

* This weight does not include Pallet weight

Model	Description	Dimension	List Price
-------	-------------	-----------	------------

Left Executive Bullet "U" Unit

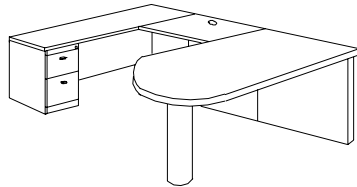

MV 3672 BTR
Right Executive Bullet Top Desk

depth	36	\$1,019.20
width	72	
height	30	
KD weight *	184	
cubic feet	9.924	
cubic meter	0.281	

MV 42 EB
Executive 42" Bridge

depth	24	\$338.00
width	42	
height	30	
KD weight *	62	
cubic feet	2.507	
cubic meter	0.071	

MV 2472 CL
Left Pedestal Credenza
(For Optional Credenzas, please see page 14 to 18)

depth	24	\$1,341.60
width	72	
height	30	
KD weight *	209	
cubic feet	19.707	
cubic meter	0.558	

Unit Total : **\$2,698.80**

Right Executive Bullet "U" Unit

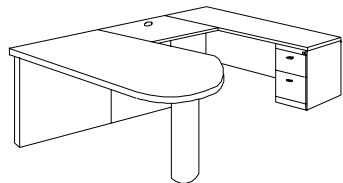

MV 3672 BTL
Left Executive Bullet Top Desk

depth	36	\$1,019.20
width	72	
height	30	
KD weight *	184	
cubic feet	9.924	
cubic meter	0.281	

MV 42 EB
Executive 42" Bridge

depth	24	\$338.00
width	42	
height	30	
KD weight *	62	
cubic feet	2.507	
cubic meter	0.071	

MV 2472 CR
Right Pedestal Credenza
(For Optional Credenzas, please see page 14 to 18)

depth	24	\$1,341.60
width	72	
height	30	
KD weight *	209	
cubic feet	19.707	
cubic meter	0.558	

Unit Total : **\$2,698.80**

* This weight does not include Pallet weight

Model	Description	Dimension	List Price
-------	-------------	-----------	------------

Left Executive Bow Top "L" Unit

MV 4272 BSR		depth	42	\$1,716.00
Right Pedestal Executive Bow Top Desk		width	72	
		height	30	
		KD weight *	278	
		cubic feet	24.792	
		cubic meter	0.702	

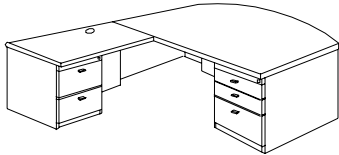

MV 48 RL		depth	24	\$910.00
Executive 48" Left Return		width	48	
		height	30	
		KD weight *	137	
		cubic feet	10.101	
		cubic meter	0.286	

Unit Total : \$2,626.00

Right Executive Bow Top "L" Unit

MV 4272 BSL		depth	42	\$1,716.00
Left Pedestal Executive Bow Top Desk		width	72	
		height	30	
		KD weight *	278	
		cubic feet	24.792	
		cubic meter	0.702	

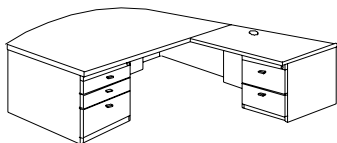

MV 48 RR		depth	24	\$910.00
Executive 48" Right Return		width	48	
		height	30	
		KD weight *	137	
		cubic feet	10.101	
		cubic meter	0.286	

Unit Total : \$2,626.00

* This weight does not include Pallet weight

Model	Description	Dimension	List Price
-------	-------------	-----------	------------

Left Executive Bow Top "L" Unit

MV 4272 BSR
Right Pedestal Executive Bow Top Desk

depth	42
width	72
height	30
KD weight *	278
cubic feet	24.792
cubic meter	0.702

\$1,716.00

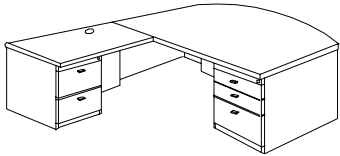

MV 42 RL
Executive 42" Left Return

depth	24
width	42
height	30
KD weight *	129
cubic feet	9.783
cubic meter	0.277

\$806.00

Unit Total :

\$2,522.00

Right Executive Bow Top "L" Unit

MV 4272 BSL
Left Pedestal Executive Bow Top Desk

depth	42
width	72
height	30
KD weight *	278
cubic feet	24.792
cubic meter	0.702

\$1,716.00

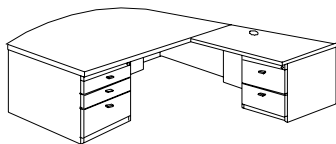

MV 42 RR
Executive 42" Right Return

depth	24
width	42
height	30
KD weight *	129
cubic feet	9.783
cubic meter	0.277

\$806.00

Unit Total :

\$2,522.00

Model	Description	Dimension	List Price
-------	-------------	-----------	------------

Left Executive " L" Unit

MV 3672 ESR
Right Pedestal Executive Desk

depth	36
width	72
height	30
KD weight *	267
cubic feet	24.298
cubic meter	0.688

\$1,632.80

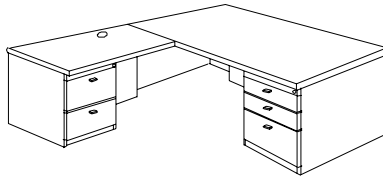

MV 48 RL
Executive 48" Left Return

depth	24
width	48
height	30
KD weight *	137
cubic feet	10.101
cubic meter	0.286

\$910.00

Unit Total :

\$2,542.80

Right Executive " L" Unit

MV 3672 ESL
Left Pedestal Executive Desk

depth	36
width	72
height	30
KD weight *	267
cubic feet	24.298
cubic meter	0.688

\$1,632.80

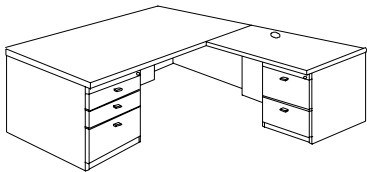

MV 48 RR
Executive 48" Right Return

depth	24
width	48
height	30
KD weight *	137
cubic feet	10.101
cubic meter	0.286

\$910.00

\$2,542.80

* This weight does not include Pallet weight

Model	Description	Dimension	List Price
-------	-------------	-----------	------------

Left Executive " L" Unit

MV 3672 ESR
Right Pedestal Executive Desk

depth 36
width 72
height 30
KD weight * 267
cubic feet 24.298
cubic meter 0.688

\$1,632.80

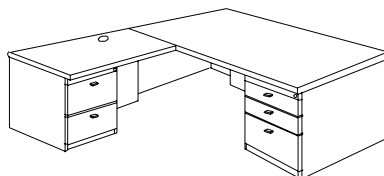

MV 42 RL
Executive 42" Left Return

depth 24
width 42
height 30
KD weight * 129
cubic feet 9.783
cubic meter 0.277

\$806.00

Unit Total : \$2,438.80

Right Executive " L" Unit

MV 3672 ESL
Left Pedestal Executive Desk

depth 36
width 72
height 30
KD weight * 267
cubic feet 24.298
cubic meter 0.688

\$1,632.80

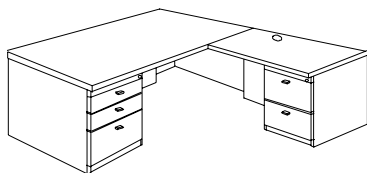

MV 42 RR
Executive 42" Right Return

depth 24
width 42
height 30
KD weight * 129
cubic feet 9.783
cubic meter 0.277

\$806.00

Unit Total : \$2,438.80

* This weight does not include Pallet weight

Model	Description	Dimension	List Price
-------	-------------	-----------	------------

Left Executive " L" Unit

MV 3666 ESR
Right Pedestal Executive Desk

depth 36
width 66
height 30
KD weight * 260
cubic feet 23.909
cubic meter 0.677

\$1,560.00

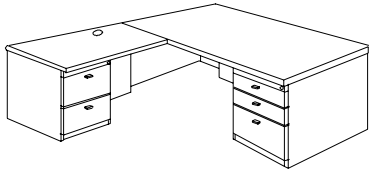

MV 48 RL
Executive 48" Left Return

depth 24
width 48
height 30
KD weight * 137
cubic feet 10.101
cubic meter 0.286

\$910.00

Unit Total : \$2,470.00

Right Executive " L" Unit

MV 3666 ESL
Left Pedestal Executive Desk

depth 36
width 66
height 30
KD weight * 260
cubic feet 23.909
cubic meter 0.677

\$1,560.00

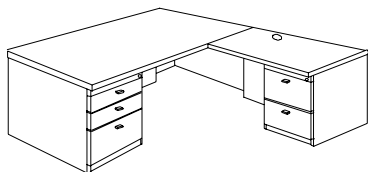

MV 48 RR
Executive 48" Right Return

depth 24
width 48
height 30
KD weight * 137
cubic feet 10.101
cubic meter 0.286

\$910.00

Unit Total : \$2,470.00

* This weight does not include Pallet weight

Model	Description	Dimension	List Price
-------	-------------	-----------	------------

Left Executive " L" Unit

MV 3666 ESR
Right Pedestal Executive Desk

depth 36
width 66
height 30
KD weight * 260
cubic feet 23.909
cubic meter 0.677

\$1,560.00

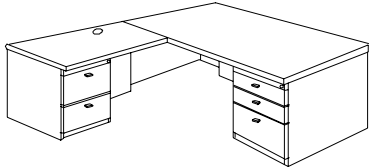

MV 42 RL
Executive 42" Left Return

depth 24
width 42
height 30
KD weight * 129
cubic feet 9.783
cubic meter 0.277

\$806.00

Unit Total : \$2,366.00

Right Executive " L" Unit

MV 3666 ESL
Left Pedestal Executive Desk

depth 36
width 66
height 30
KD weight * 260
cubic feet 23.909
cubic meter 0.677

\$1,560.00

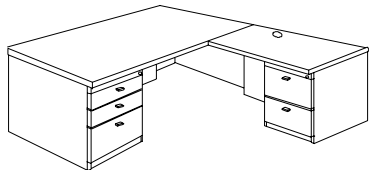

MV 42 RR
Executive 42" Right Return

depth 24
width 42
height 30
KD weight * 129
cubic feet 9.783
cubic meter 0.277

\$806.00

Unit Total : \$2,366.00

* This weight does not include Pallet weight

Model	Description	Dimension	List Price
-------	-------------	-----------	------------

Left Executive " L" Unit

MV 3066 ESR

Right Pedestal Executive Desk
24" X 66" Chassis with 30" X 66" Worksurface

depth	30
width	66
height	30
KD weight *	211
cubic feet	16.881
cubic meter	0.478

\$1,336.40

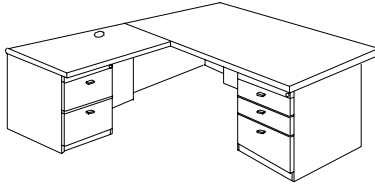

MV 48 RL

Executive 48" Left Return

depth	24
width	48
height	30
KD weight *	137
cubic feet	10.101
cubic meter	0.286

\$910.00

Unit Total :

\$2,246.40

Right Executive " L" Unit

MV 3066 ESL

Left Pedestal Executive Desk
24" X 66" Chassis with 30" X 66" Worksurface

depth	30
width	66
height	30
KD weight *	211
cubic feet	16.881
cubic meter	0.478

\$1,336.40

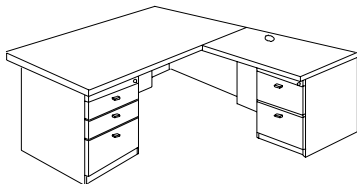

MV 48 RR

Executive 48" Right Return

depth	24
width	48
height	30
KD weight *	137
cubic feet	10.101
cubic meter	0.286

\$910.00

Unit Total :

\$2,246.40

* This weight does not include Pallet weight

Model	Description	Dimension	List Price
-------	-------------	-----------	------------

Left Executive " L" Unit

MV 3066 ESR	depth	30	\$1,336.40
Right Pedestal Executive Desk	width	66	
24" X 66" Chassis with 30" X 66" Worksurface	height	30	
	KD weight *	211	
	cubic feet	16.881	
	cubic meter	0.478	

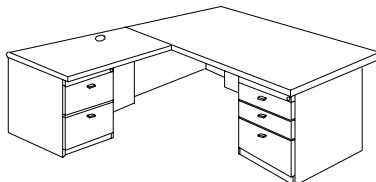

MV 42 RL	depth	24	\$806.00
Executive 42" Left Return	width	42	
	height	30	
	KD weight *	129	
	cubic feet	9.783	
	cubic meter	0.277	

Unit Total : \$2,142.40

Right Executive " L" Unit

MV 3066 ESL	depth	30	\$1,336.40
Left Pedestal Executive Desk	width	66	
24" X 66" Chassis with 30" X 66" Worksurface	height	30	
	KD weight *	211	
	cubic feet	16.881	
	cubic meter	0.478	

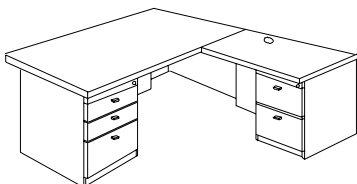

MV 42 RR	depth	24	\$806.00
Executive 42" Right Return	width	42	
	height	30	
	KD weight *	129	
	cubic feet	9.783	
	cubic meter	0.277	

Unit Total : \$2,142.40

* This weight does not include Pallet weight

Model	Description	Dimension	List Price
-------	-------------	-----------	------------

Left Executive P "L" Unit

MV 4272 PTR
Right Executive P Top Desk

depth 42
width 72
height 30
KD weight * 191
cubic feet 10.418
cubic meter 0.295

\$1,071.20

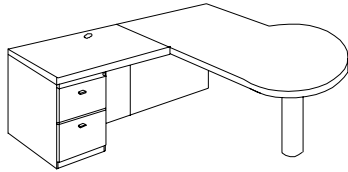

MV 48 RL
Executive 48" Left Return

depth 24
width 48
height 30
KD weight * 137
cubic feet 10.101
cubic meter 0.286

\$910.00

Unit Total :

\$1,981.20

Right Executive P "L" Unit

MV 4272 PTL
Left Executive P Top Desk

depth 42
width 72
height 30
KD weight * 191
cubic feet 8.582
cubic meter 0.243

\$1,071.20

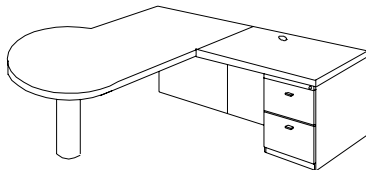

MV 48 RR
Executive 48" Right Return

depth 24
width 48
height 30
KD weight * 137
cubic feet 10.101
cubic meter 0.286

\$910.00

Unit Total :

\$1,981.20

Model	Description	Dimension	List Price
-------	-------------	-----------	------------

Left Executive P "L" Unit

MV 4272 PTR
Right Executive P Top Desk

depth 42
width 72
height 30
KD weight * 191
cubic feet 8.582
cubic meter 0.243

\$1,071.20

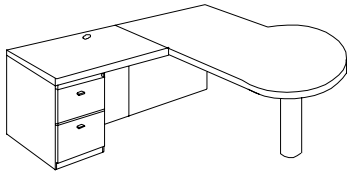

MV 42 RL
Executive 42" Left Return

depth 24
width 42
height 30
KD weight * 129
cubic feet 9.783
cubic meter 0.277

\$806.00

Unit Total : \$1,877.20

Right Executive P "L" Unit

MV 4272 PTL
Left Executive P Top Desk

depth 42
width 72
height 30
KD weight * 191
cubic feet 8.582
cubic meter 0.243

\$1,071.20

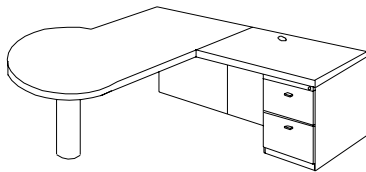

MV 42 RR
Executive 42" Right Return

depth 24
width 42
height 30
KD weight * 129
cubic feet 9.783
cubic meter 0.277

\$806.00

Unit Total : \$1,877.20

* This weight does not include Pallet weight

Model	Description	Dimension	List Price
-------	-------------	-----------	------------

Left Executive Bullet "L" Unit

MV 3672 BTR	depth	36	\$1,019.20
Right Executive Bullet Top Desk	width	72	
	height	30	
	KD weight *	184	
	cubic feet	8.087	
	cubic meter	0.229	

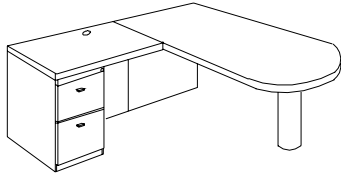

MV 48 RL	depth	24	\$910.00
Executive 48" Left Return	width	48	
	height	30	
	KD weight *	137	
	cubic feet	10.101	
	cubic meter	0.286	

Unit Total : \$1,929.20

Right Executive Bullet "L" Unit

MV 3672 BTL	depth	36	\$1,019.20
Left Executive Bullet Top Desk	width	72	
	height	30	
	KD weight *	184	
	cubic feet	8.087	
	cubic meter	0.229	

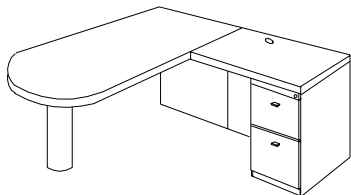

MV 48 RR	depth	24	\$910.00
Executive 48" Right Return	width	48	
	height	30	
	KD weight *	137	
	cubic feet	10.101	
	cubic meter	0.286	

Unit Total : \$1,929.20

Model	Description	Dimension	List Price
-------	-------------	-----------	------------

Left Executive Bullet "L" Unit

MV 3672 BTR Right Executive Bullet Top Desk	depth	36	\$1,019.20
	width	72	
	height	30	
	KD weight *	184	
	cubic feet	9.924	
	cubic meter	0.281	

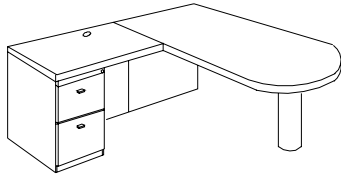

MV 42 RL Executive 42" Left Return	depth	24	\$806.00
	width	42	
	height	30	
	KD weight *	129	
	cubic feet	9.783	
	cubic meter	0.277	

Unit Total : \$1,825.20

Right Executive Bullet "L" Unit

MV 3672 BTL Left Executive Bullet Top Desk	depth	36	\$1,019.20
	width	72	
	height	30	
	KD weight *	184	
	cubic feet	9.924	
	cubic meter	0.281	

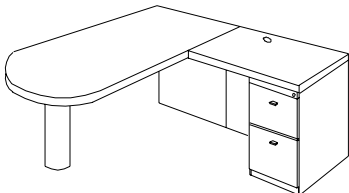

MV 42 RR Executive 42" Right Return	depth	24	\$806.00
	width	42	
	height	30	
	KD weight *	129	
	cubic feet	9.783	
	cubic meter	0.277	

Unit Total : \$1,825.20

* This weight does not include Pallet weight

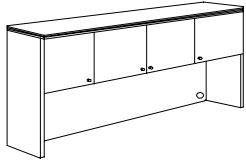
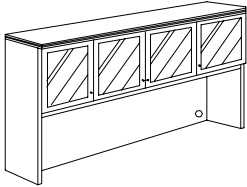
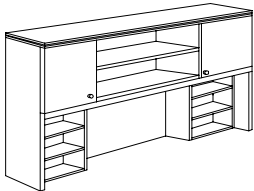
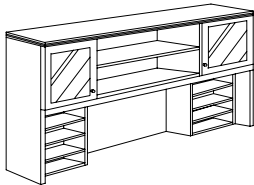
Model	Description	Dimension		List Price
MV 1672 CH 	Credenza Hutch	depth	16	\$1,300.00
		width	72	
		height	42	
		KD Weight *	176	
		cubic feet	6.922	
		cubic meter	0.196	
		<hr/>		
MV 1672 CHG 	Glass Door Credenza Hutch (Clear or frosted)	depth	16	\$1,404.00
		width	72	
		height	42	
		KD Weight *	177	
		cubic feet	6.922	
		cubic meter	0.196	
		<hr/>		
MV 1672 HH 	Credenza Home Hutch	depth	16	\$1,554.80
		width	72	
		height	42	
		KD Weight *	195	
		cubic feet	13.067	
		cubic meter	0.370	
		<hr/>		
MV 1672 HHG 	Glass door Credenza Home Hutch (Clear or frosted)	depth	16	\$1,612.00
		width	72	
		height	42	
		KD weight *	195	
		cubic feet	11.160	
		cubic meter	0.316	

* This weight does not include Pallet weight

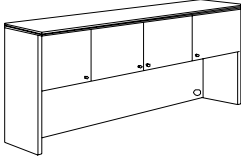
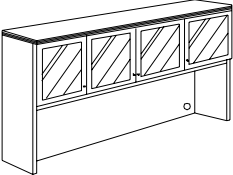
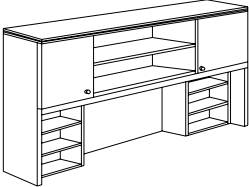
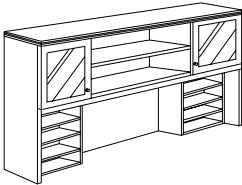
Model	Description	Dimension	List Price	
MV 1666 CH	Credenza Hutch	depth	16	\$1,185.60
		width	66	
	height	42		
	KD Weight *	168		
	cubic feet	6.357		
	cubic meter	0.180		
				
MV 1666 CHG	Credenza Hutch Glass Door Credenza Hutch (Clear or frosted)	depth	16	\$1,320.80
		width	66	
	height	42		
	KD Weight *	167		
	cubic feet	6.357		
	cubic meter	0.180		
				
MV 1666 HH	Credenza Home Hutch	depth	16	\$1,450.80
		width	66	
	height	42		
	KD Weight *	189		
	cubic feet	11.972		
	cubic meter	0.339		
				
MV 1666 HHG	Glass door Credenza Home Hutch (Clear or frosted)	depth	16	\$1,508.00
		width	66	
	height	42		
	KD weight *	86		
	cubic feet	10.670		
	cubic meter	0.302		
				

* This weight does not include Pallet weight

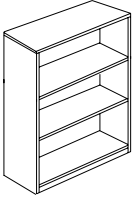
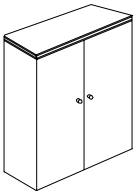
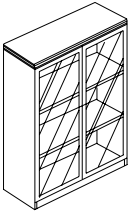
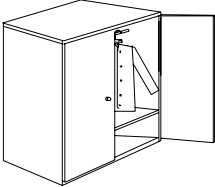
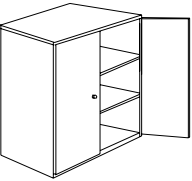
Model	Description	Dimension	List Price
MV 1636 SHO 	Open Shelf Storage Hutch	depth 16	\$572.00
		width 36	
		height 42	
		KD weight * 101	
		cubic feet 3.814	
		cubic meter 0.108	
MV 1636 SHD 	Storage Hutch	depth 16	\$884.00
		width 36	
		height 42	
		KD weight * 132	
		cubic feet 4.980	
		cubic meter 0.141	
MV 1636 SHG 	Storage Hutch with Glass doors (Clear or frosted)	depth 16	\$826.80
		width 36	
		height 42	
		KD Weight * 126	
		cubic feet 5.615	
		cubic meter 0.159	
MV 2436 WCH 	Wardrobe Cabinet Hutch	depth 24	\$1,175.20
		width 36	
		height 42	
		KD weight * 157	
		cubic feet 5.933	
		cubic meter 0.168	
MV 2436 SCH 	Storage Cabinet Hutch	depth 24	\$1,300.00
		width 36	
		height 42	
		KD weight * 170	
		cubic feet 6.851	
		cubic meter 0.194	

* This weight does not include Pallet weight

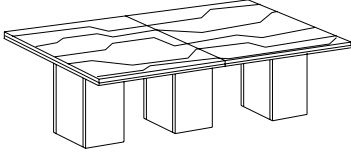
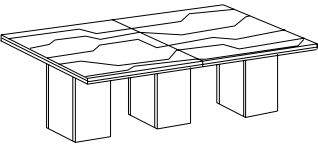
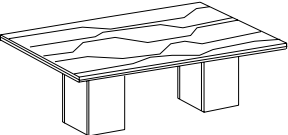
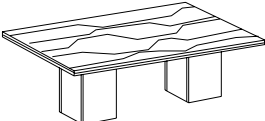
Model	Description	Dimension	List Price
MV 48144 ACT	12-ft Rectangular Conference Table	depth 48 width 144 height 30 KD weight * 486 cubic feet 30.937 cubic meter 0.876	\$2,381.60
			
MV 48120 ACT	10-ft Rectangular Conference Table	depth 48 width 120 height 30 KD Weight * 448 cubic feet 29.736 cubic meter 0.844	\$1,924.00
			
MV 4896 ACT	8-ft Rectangular Conference Table	depth 48 width 96 height 30 KD Weight * 328 cubic feet 21.684 cubic meter 0.614	\$1,508.00
			
MV 3672 ACT	6-ft Rectangular Conference Table	depth 36 width 72 height 30 KD Weight * 174 cubic feet 11.902 cubic meter 0.337	\$1,196.00
			

* This weight does not include Pallet weight

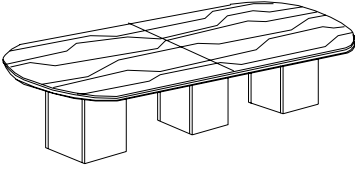
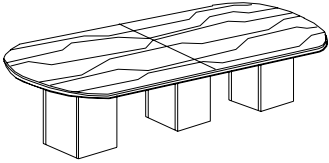
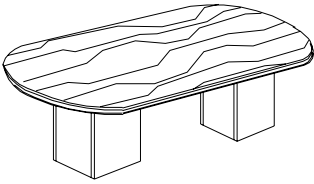
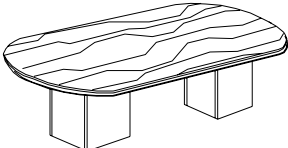
Model	Description	Dimension	List Price		
MV 48144 RTCT	12-ft Racetrack Conference Table	depth	48		
		width	144		
		height	30		
		KD weight *	471		
		cubic feet	30.937		
		cubic meter	0.876		
					\$2,490.80
		<hr/>			
		MV 48120 RTCT	10-ft Racetrack Conference Table	depth	48
width	120				
		height	30		
		KD weight *	433		
		cubic feet	29.807		
		cubic meter	0.844		
					\$2,262.00
		<hr/>			
		MV 4896 RTCT	8-ft Racetrack Conference Table	depth	48
width	96				
		height	30		
		KD weight *	313		
		cubic feet	21.684		
		cubic meter	0.614		
					\$1,508.00
		<hr/>			
		MV 3672 RTCT	6-ft Racetrack Conference Table	depth	36
width	72				
		height	30		
		KD weight *	165		
		cubic feet	11.902		
		cubic meter	0.337		
					\$1,196.00

* This weight does not include Pallet weight

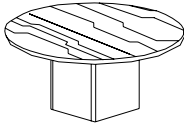
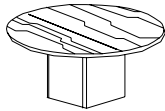
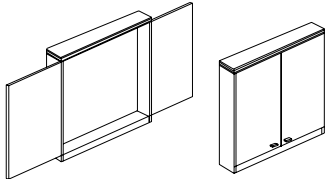
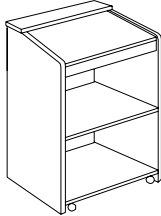
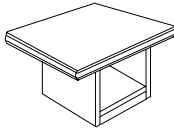
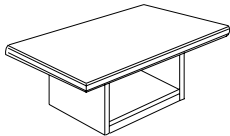
Model	Description	Dimension		List Price
MV 48 RCT	Round Conference Table	diameter	48	\$806.00
		height	30	
		KD Weight *	147	
		cubic feet	10.772	
		cubic meter	0.305	
MV 42 RCT	Round Conference Table	diameter	42	\$696.80
		height	30	
		KD Weight *	133	
		cubic feet	10.312	
		cubic meter	0.292	
MV 4848 VB	Visual Board with white board	depth	5	\$1,144.00
		width	47	
		height	47	
		KD Weight *	112	
		cubic feet	9.641	
		cubic meter	0.273	
MV 24 LT	Lectern with fixed shelf and casters	depth	20	\$624.00
		width	24	
		height	47	
		KD Weight *	104	
		cubic feet	3.426	
		cubic meter	0.097	
MV 2424 OT	Occasional End Table	depth	24	\$353.60
		width	24	
		height	20	
		KD Weight *	42	
		cubic feet	3.779	
		cubic meter	0.107	
MV 2448 OT	Occasional Coffee Table	depth	24	\$488.80
		width	48	
		height	18	
		KD Weight *	67	
		cubic feet	8.017	
		cubic meter	0.227	

* This weight does not include Pallet weight

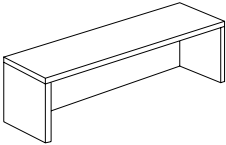
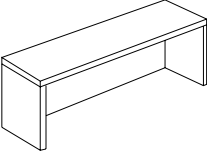
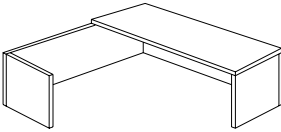
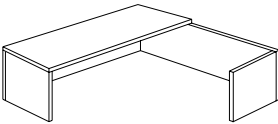
Model	Description	Dimension		List Price
MV 1472 TC 	Transaction Counter	depth	14	\$572.00
		width	72	
		height	14	
		KD Weight *	66	
		cubic feet	2.755	
		cubic meter	0.078	
		<hr/>		
MV 1466 TC 	Transaction Counter	depth	14	\$535.60
		width	66	
		height	14	
		KD Weight *	57	
		cubic feet	2.543	
		cubic meter	0.072	
		<hr/>		
Left L Unit Transaction Counter				
MV 8472 TCL L 	Front 1472 TC Transaction Counter	depth	14	\$572.00
		width	72	
		height	14	
		KD weight *	66	
		cubic feet	2.755	
		cubic meter	0.078	
		Side 84 CL L Left L Transaction Counter		
width	13			
height	14			
KD weight *	47			
cubic feet	2.578			
cubic meter	0.073			
Unit Total :				\$936.00
<hr/>				
Right L Unit Transaction Counter				
MV 8472 TCL R 	Front 1472 TC Transaction Counter	depth	14	\$572.00
		width	72	
		height	14	
		KD weight *	66	
		cubic feet	2.755	
		cubic meter	0.078	
		Side 84 CL R Right L Transaction Counter		
width	13			
height	14			
KD weight *	47			
cubic feet	2.578			
cubic meter	0.073			
Unit Total :				\$936.00

* This weight does not include Pallet weight

Model	Description	Dimension	List Price
-------	-------------	-----------	------------

Left L Unit Transaction Counter

MV 8466 TCL L

Front 1466 TC
Transaction Counter

depth	14
width	66
height	14
KD weight *	57
cubic feet	2.543
cubic meter	0.072

\$535.60

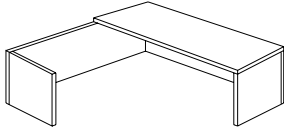

Side 84 CL L
Left L Transaction Counter

depth	84
width	13
height	14
KD weight *	47
cubic feet	2.578
cubic meter	0.073

\$364.00

Unit Total : \$899.60

Right L Unit Transaction Counter

MV 8466 TCL R

Front 1466 TC
Transaction Counter

depth	14
width	66
height	14
KD weight *	57
cubic feet	2.543
cubic meter	0.072

\$535.60

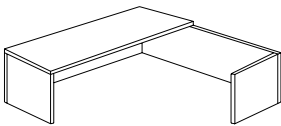

Side 84 CL R
Right L Transaction Counter

depth	84
width	13
height	14
KD weight *	47
cubic feet	2.578
cubic meter	0.073

\$364.00

Unit Total : \$899.60

* This weight does not include Pallet weight

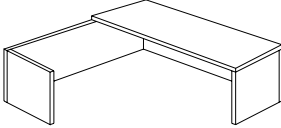
Model	Description	Dimension	List Price	
Left L Unit Transaction Counter				
MV 7872 TCL L	Front 1472 TC Transaction Counter	depth	14	\$572.00
		width	72	
		height	14	
		KD weight *	66	
		cubic feet	2.755	
		cubic meter	0.078	
				
	Side 78 CL L Left L Transaction Counter	depth	78	\$338.00
		width	13	
		height	14	
		KD weight *	41	
		cubic feet	2.225	
		cubic meter	0.063	
		Unit Total :		

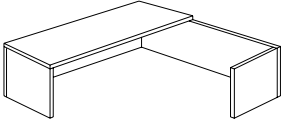
Right L Unit Transaction Counter				
MV 7872 TCL R	Front 1472 TC Transaction Counter	depth	14	\$572.00
		width	72	
		height	14	
		KD weight *	66	
		cubic feet	2.755	
		cubic meter	0.078	
				
	Side 78 CL R Right L Transaction Counter	depth	78	\$338.00
		width	13	
		height	14	
		KD weight *	41	
		cubic feet	2.225	
		cubic meter	0.063	
		Unit Total :		

Model	Description	Dimension	List Price
-------	-------------	-----------	------------

Left L Unit Transaction Counter

MV 7866 TCL L

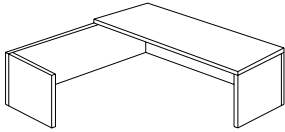

Front 1466 TC
Transaction Counter

depth	14
width	66
height	14
KD weight *	57
cubic feet	2.543
cubic meter	0.072

\$535.60

Side 78 CL R
Left L Transaction Counter

depth	78
width	13
height	14
KD weight *	41
cubic feet	2.225
cubic meter	0.063

\$338.00

Unit Total : \$873.60

Right L Unit Transaction Counter

MV 7866 TCL R

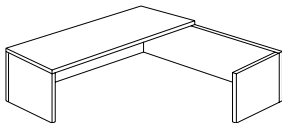

Front 1466 TC
Transaction Counter

depth	14
width	66
height	14
KD weight *	57
cubic feet	2.543
cubic meter	0.072

\$535.60

Side 78 CL R
Right L Transaction Counter

depth	78
width	13
height	14
KD weight *	41
cubic feet	2.225
cubic meter	0.063

\$338.00

Unit Total : \$873.60

* This weight does not include Pallet weight

Model	Description	Dimension	List Price
-------	-------------	-----------	------------

Left L Unit Glass Transaction Counter

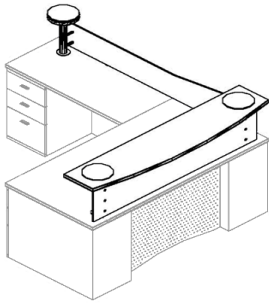

MV 8472 TCG L
Left Transaction Glass Counter

depth	84
width	72
height	13
KD weight *	227
cubic feet	7.628
cubic meter	0.216

\$1,088.88

Right L Unit Glass Transaction Counter

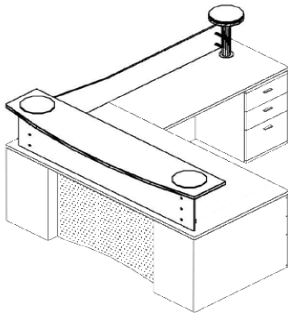

MV 8472 TCG R
Right Transaction Glass Counter

depth	84
width	72
height	13
KD weight *	227
cubic feet	7.628
cubic meter	0.216

\$1,088.88

Left L Unit Glass Transaction Counter

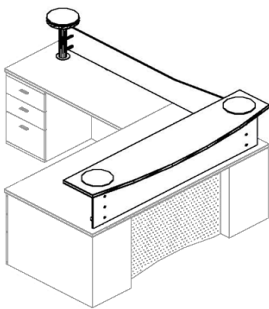

MV 7872 TCG L
Left Transaction Glass Counter

depth	78
width	72
height	13
KD weight *	219
cubic feet	7.487
cubic meter	0.212

\$1,076.40

Right L Unit Glass Transaction Counter

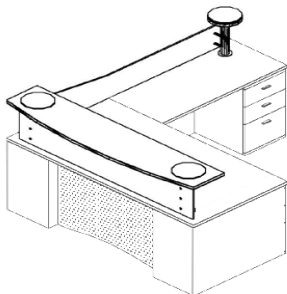

MV 7872 TCG R
Right Transaction Glass Counter

depth	78
width	72
height	13
KD weight *	219
cubic feet	7.487
cubic meter	0.212

\$1,076.40

* This weight does not include Pallet weight

Model	Description	Dimension	List Price
-------	-------------	-----------	------------

Left L Unit Glass Transaction Counter

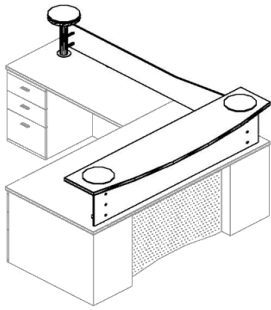

MV 8466 TCG L
Left Transaction Glass Counter

depth	84
width	66
height	13
KD weight *	219
cubic feet	7.165
cubic meter	0.203

\$1,056.64

Right L Unit Glass Transaction Counter

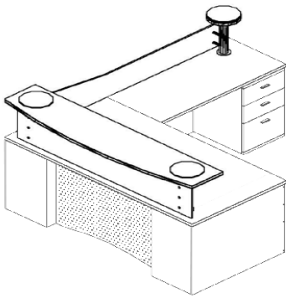

MV 8466 TCG R
Right Transaction Glass Counter

depth	84
width	66
height	13
KD weight *	219
cubic feet	7.165
cubic meter	0.203

\$1,056.64

Left L Unit Glass Transaction Counter

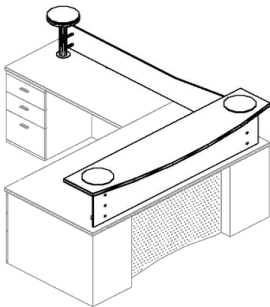

MV 7866 TCG L
Left Transaction Glass Counter

depth	78
width	66
height	13
KD weight *	212
cubic feet	7.028
cubic meter	0.199

\$1,045.20

Right L Unit Glass Transaction Counter

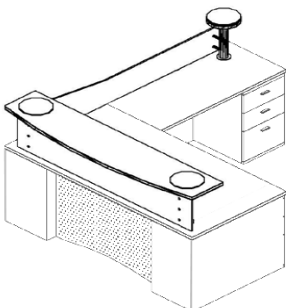

MV 7866 TCG R
Right Transaction Glass Counter



depth	78
width	66
height	13
KD weight *	212
cubic feet	7.028
cubic meter	0.199

\$1,045.20

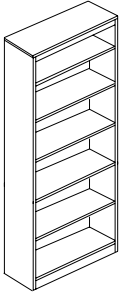
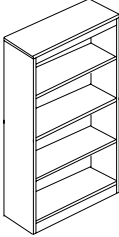
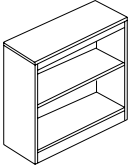
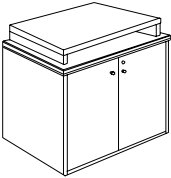
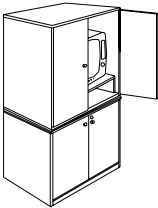
* This weight does not include Pallet weight

Model	Description	Dimension		List Price
MV 3672 BC 	Bookcases	depth	12	\$696.80
		width	36	
		height	72	
		KD Weight *	112	
		cubic feet	5.192	
		cubic meter	0.147	
MV 3648 BC 	Bookcases	depth	12	\$509.60
		width	36	
		height	48	
		KD Weight *	79	
		cubic feet	3.532	
		cubic meter	0.100	
MV 3630 BC 	Bookcases	depth	12	\$322.40
		width	36	
		height	30	
		KD Weight *	53	
		cubic feet	2.331	
		cubic meter	0.066	
MV 2436 LAV 	Low AV Cabinet	depth	24	\$1,154.40
		width	36	
		height	42	
		KD weight *	172	
		cubic feet	6.781	
		cubic meter	0.192	
MV 2436 HAV 	High AV Cabinet	depth	24	\$2,215.20
		width	36	
		height	72	
		KD weight *	284	
		cubic feet	11.619	
		cubic meter	0.329	

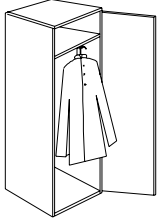
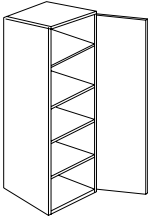
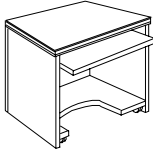
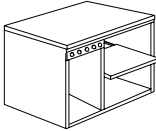
* This weight does not include Pallet weight

Model	Description	Dimension	List Price
MV 2418 HWC 	High Wardrobe Cabinet	depth 24 width 18 height 72 KD weight * 142 cubic feet 1.800 cubic meter 0.510	\$1,170.00
MV 2418 HSC 	High Storage Cabinet	depth 24 width 18 height 72 KD weight * 162 cubic feet 5.333 cubic meter 0.151	\$1,336.40
MV 2436 CPS 	Computer / Printer Stand	depth 24 width 36 height 30 KD Weight * 99 cubic feet 4.026 cubic meter 0.114	\$696.80
MV 2436 TP 	Technology Pedestal	depth 24 width 36 height 30 KD weight * 172 cubic feet 6.781 cubic meter 0.192	\$728.00
MV 2415 MBF 	Mobile Pedestal	depth 24 width 16 height 30 KD weight * 88 cubic feet 7.205 cubic meter 0.204	\$644.80

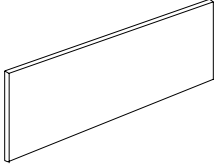
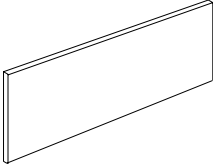
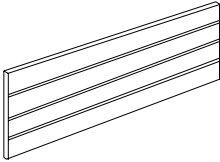
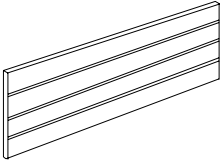
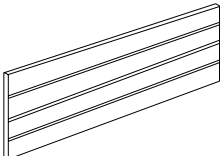

* This weight does not include Pallet weight

Model	Description	Dimension	List Price
TB 72	Tack Board	depth width 70 height 16 KD weight *	\$452.40
			
TB 66	Tack Board	depth width 64 height 16 KD weight *	\$442.00
			
SW 72	Slatwall Plastic Toolbar	depth width height KD weight *	\$93.60
			
SW 66	Slatwall Plastic Toolbar	depth width height KD weight *	\$88.40
			
SW 30	Slatwall Plastic Toolbar	depth width height KD weight *	\$46.80
			

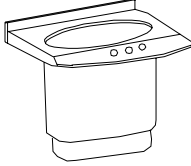
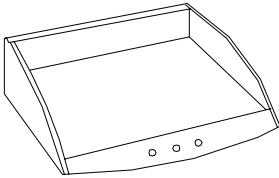
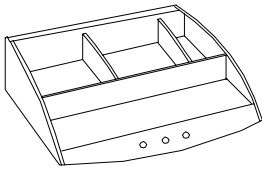
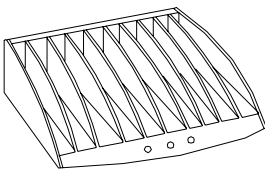
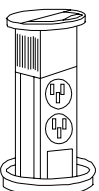

* This weight does not include Pallet weight

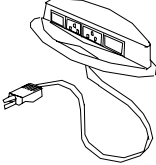
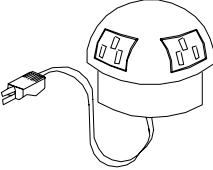
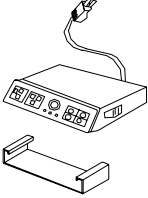
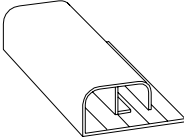
Model	Description	Dimension	List Price
SUH1	Slatwall Utensil Holder	depth width height KD weight *	\$20.80
			
SPT1	Slatwall Paper Tray	depth width height KD weight *	\$46.80
			
SAT 1	Slatwall Accessory Tray	depth width height KD weight *	\$46.80
			
SCD 1	Slatwall CD Holder	depth width height KD weight *	\$36.40
			
PDCR1	Retractable Power / Data Center	depth width height KD weight *	\$530.40
			

* This weight does not include Pallet weight

Model	Description	Dimension		List Price
PDCT1 	Work Surface Power / Data Center	depth width height KD weight *		\$530.40
PDCT2 	Work Surface Power / Data Pod	depth width height KD weight *		\$520.00
PDCU1 	Under Top Power / Data Director	depth width height KD weight *		\$166.40
RW1 	Wire Management Race Way	length 1-ft width 1.18" height 2.36" KD weight *	\$8.32	
TG1 	Work Surface Grommet	depth width height KD weight *		\$20.80

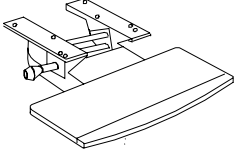
* This weight does not include Pallet weight

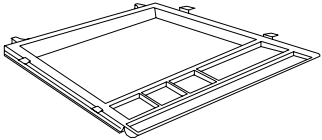
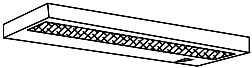
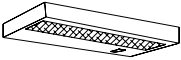
Model	Description	Dimension		List Price
26187 VKT 	Keyboard Tray - Medium Density Fiberboard tray - Features 21-3/4" width for ample keyboard space - Soft-touch black vinyl covering	depth	11	\$364.00
		width	21-3/4	
26188 VMP 	Mouse Platform - Steel, Black Powdercoat - For left or right hand operation	depth	8-3/8	\$109.20
		width	8-3/8	
89710 CD 	Central Drawer - Wide pencil drawer - With ball bearing slides - Black color, for use with any desk	depth	18	\$119.60
		width	23	
48 TL 	Task light	depth	7	\$260.00
		width	48	
		height	2	
24 TL 	Task light	depth	7	\$234.00
		width	24	
		height	2	

* This weight does not include Pallet weight